

使用說明書 HOW TO USE

日立多門電冰箱 REFRIGERATOR-FREEZER

HITACHI
Inspire the Next

只限在新加坡·香港·越南·
印度尼西亞·印度使用
For use in Singapore, Hong Kong,
Vietnam, Indonesia and India only.

家庭用 For household use

型號 Model	R-E6800XS	R-E6800S	R-E6800XND	R-E6800ND
	R-E6800XH	R-E6800H	R-E6800XN	R-E6800N
	R-E6800XV	R-E6800V		



日本製 Made in Japan

六門 6 doors

非常感謝您購買日立電冰箱。

此電冰箱僅供家庭使用，請勿使用於商業用途和儲存食品以外的目的上。

請詳閱本使用說明書，以確保正確使用。

使用前請務必詳閱「安全上之注意事項」。

請妥善保管本使用說明書與保證書，當將電冰箱交給他人或在別的場所使用時，以及交給回收工場時，請將本使用說明書隨電冰箱一同轉交。

Thank you very much for purchasing a Hitachi Refrigerator.

This refrigerator is designed for home use only. Do not use this refrigerator for the business use and/or any purpose other than storing food.

Please read this operation manual carefully and ensure you use the appliance correctly. In particular, be sure to read the "Safety Suggestions" section of this operation manual before use.

Please keep this operation manual along with your guarantee card.

Hand over this operation manual together with the refrigerator when the refrigerator is passed to a third party and used in a different location, or when it is sent to a recycling plant.

● 購買後初次使用時。 → 10, 11頁

初次使用時，庫內冷卻可能需要約4小時至24小時以上。

● 請遵守可容納食物的高度及食品之間空開間隙儲放。 → 18, 22頁

過分塞堵食物，會造成食品及袋子被門夾住關不緊，製冷效率低，不能製冰等。

● It takes time to cool for the first time. → Pg.46, 47

It may take more than 4 ~ 24 hours to fully cool.

● Make sure that no food protrudes beyond the storage height limit of each compartment, and allow clearance between each food in each compartment. → Pg.54, 58

Otherwise, food and/or package may not be stored in each compartment properly, and as a result, the door may not be closed completely. It may cause the refrigerator not to cool sufficiently and/or not to make ice.

特長 FEATURES

保存蔬菜的營養素及水嫩

■ 蔬果睡眠保鮮

蔬果保鮮室的下層保鮮盒的內側，採用光觸媒來保存蔬果鮮度及營養素的「睡眠保鮮」功能。利用二氧化碳來抑制蔬菜營養素的消耗，保持鮮度。

Keeping freshness and preserving nutrients of vegetables

Aero-care Vege. Compartment

Adopted [Photocatalyst Preservation] function keeps freshness and preserves nutrients by making use of the photocatalyst at the back of the lower case of Vegetable Compartment. Thanks to the effects of carbon dioxide, it will restrict consumption of vegetables' nutrients and keep them fresh.

利用「睡眠保鮮」功能來保持肉類、魚類的鮮度。

■ 真空冰溫

以約 0.8 氣壓的「真空保存」抑制食品的氧化，保持鮮度及營養素。蔬果保鮮室也使用「睡眠保鮮」技術，及新採用的「抗氧化保鮮盒」，抑制鮮度降低。

※ 所謂真空是指壓力比一大氣壓還要低的空間。真空冰溫室內的壓力約 0.8 氣壓，因為比大氣壓來要低，本公司稱之為真空。

Keeping meat and fish fresh by [Photocatalyst Preservation] function, etc.

Vacuum Compartment

Approx. 0.8 hPa of [Vacuum Preservation] keeps freshness and preserves nutrients by restricting oxidation. [Photocatalyst Preservation] technology used for the Vegetable Compartment and newly adopted [Antioxidant Fresh Cassette] maintain freshness.

※ Vacuum means the space where the pressure is lower than the atmosphere pressure. The pressure in the Vacuum compartment is about 0.8 hPa which is lower than the atmosphere pressure, so Hitachi calls such state as vacuum.

利用「霜能再利用冷卻」及真空隔熱材等

■ 省能源 & 大容量

藉由「霜能再利用冷卻」等的各種省能源技術來降低電力的消耗。如果想要更節省電力時，可以選擇 [Save] 模式。在結構上還巧下功夫，不僅利用真空隔熱材料達到冰箱的薄壁化，還讓定格內的容積更寬廣，盡可能讓層架、置物盒、抽屜加大空間，增加實際食品的收納量。

By using [Frost Recycle Cooling] and vacuum insulation, etc.

Energy saving & large capacity

Power consumption is reduced more thanks to various energy-saving technologies including "Frost Recycle Cooling" and others. In addition, [Energy Saving] mode is available for saving energy further.

We have devised ways of increasing the rated internal capacity by enlarging shelves, pockets and slide cases as much as possible to store more foods while using vacuum insulation to reduce the wall thickness.

正因為大容量，才能有輕鬆操作的電動功能

■ 電動冷藏室門 & 電動抽屜

※ 電動冷藏室門只有 R-E6800X 型號配備

Convenient Auto Drawer especially for large storage capacity

Auto Door & Auto Drawer

※ Auto Door is available only for R-E6800X type.

[三重抗菌除臭]

利用三種除臭素材的完美組合，有效地捕捉並去除冰箱內含有硫磺系、氮系、醛系、酸系等四大異味分子。此外，並可抑制濾網所捕捉的細菌活動。

除臭濾網具有除菌效果。

●試驗機關：一般財團法人 BOKEN 品質評價機構 ●試驗方法：濾網密著法 (JIS Z 2801) ●處理零件名：濾網 ●除菌方法：將氧化觸媒塗抹在濾網 ●對象：濾網所捕捉的細菌 ●試驗結果：24 小時後達到 99% 的除菌效果。只是濾網單體的性能。此除菌效果並無法遍及冰箱內整體及所有食品。

[Triple Power Deodorizing Effect]

A combination of 3 types of deodorizing materials deodorize various odorous substances in the refrigerator including 4 major odors such as sulfur, nitrogen, aldehyde and oxygen odors. Activities of bacteria collected by the filter are also restricted.

Deodorant filter has the effect of sterile filtration.

● Testing laboratory: Boken Quality Evaluation Institute, a general incorporate foundation ● Test method: Film contacting method (JIS Z 2801) ● Name of the part used for treatment: Filter ● Sterilization method: applying oxidation catalyst to the filter ● Target: bacteria collected by the filter ● Test result: sterilization effect of 99 % after 24 hours by using a filter only. This does not always effect on the entire refrigerator or foods.

常見問題 FREQUENTLY-ASKED QUESTIONS (FAQs)

無法結冰時

→ 34頁

If the ice is not made

→ Pg.70

冰箱內冷度不夠時

→ 34頁

If the refrigerator is not cooled down well

→ Pg.70

結霜或結露時

→ 35頁

If frost or dew is formed

→ Pg.71

發出異常聲音時

→ 35頁

Abnormal operating sound

is generated

→ Pg.71

發現真空冰溫可能有異常時

→ 36頁

There is something strange with the Vacuum Compartment

→ Pg.72

顯示燈閃爍時

→ 36頁

If any indicator lamp blinks

→ Pg.72

目錄

使用之前

安全上的注意事項	4
確認事項	8
各室的名稱・存放食物	8
附屬品	8
操作面板的功能	9
事前準備	10
使用前的準備	10
移動・搬運的事前準備 (搬家時)	11

使用方法

電動冷藏室門	12
設定電動冷藏室門	12
使用電動冷藏室門	12
電動抽屜	13
設定電動抽屜	13
使用電動抽屜	13
冷藏室	14
調整置物架・層架的高度	14
使用活動式萬用盒	15
調節冷藏室溫度	15
急速冷卻食品 (急冷藏)	15
真空冰溫室	16
開閉真空冰溫室門	16
變更真空冰溫室的設定	17
冷凍室	18
使用上層冷凍室	18
使用下層冷凍室	18
食品收納時請格外注意	18
調節冷凍室的溫度	19
將食品急速冷凍 (急冷凍)	19
製冰室 (自動製冰機)	20
製冰方法	20
急速製冰	21
製冰停止	21
告知給水警示燈	21
「On」顯示為閃爍時	21
儲冰盒的冰塊收納量・製冰時間	21
蔬果保鮮室	22
收納食品	22
食品收納時請格外注意	22
使用蔬果睡眠保鮮空間	23
若想以更冷的溫度來保鮮時 (蔬果室強)	23
各種功能	24
「節電」模式的設定	24
eco 運轉顯示燈	24
操作面板鎖定功能	25
箱門警報器	25
箱門警報器及操作音的音量調節	25
將防止結露的加熱器設定為弱	26
溫度微調節 (冷藏室・冷凍室)	27

保養方法

保養方法〈定期檢查〉	28
電源插頭 / 冰箱背面・地板 / 箱門表面	28
各層架・置物架・置物盒 / 箱門密封墊 / 液汁承接處	28
真空冰溫室 / 電動抽屜	29
製冰機清潔	30
給水槽 / 製冰盤	31
卸除組件的方法・安裝的方法	32
可調式層架上段・中段 (玻璃層架)	32
箱門置物架	32
固定層架	32
可調式層架下段	32
真空冰溫室	32
儲冰盒 (製冰室)・上層冷凍盒 (上層冷凍室)	33
中層滑動盒・下層冷凍盒 (下層冷凍室)	33
上層滑動盒・下層置物盒 (蔬果保鮮室)	33
拉取式門的安裝方法 (製冰室・上層冷凍室・下層冷凍室・蔬果保鮮室)	33

遇到問題時

遇到問題時	34
初次使用時	34
操作面板	34
自動製冰不正常	34
不冷	34
結霜・結露	35
太冷	35
箱門高低不平衡以及歪斜	35
聲音不對	35
冰箱發熱	35
有異味	36
真空冰溫室的問題	36
操作部的「  」顯示等呈閃爍的狀態	36
電動冷藏室門	37
電動抽屜	37
其他	37
另購零件	38
有關碳氫化合物的冰箱 / 可容納的食品重量	75

安全上的注意事項

請務必遵守

為了防止危害到使用者或其他人及造成財務上的損失，請務必遵守以下事項。

■ 以下將以標示方式，區分及說明忽視標示內容而誤用時所產生的危害與損失程度。



警告

此標示欄表示「可能會造成死亡或嚴重人身傷害」。



注意

此標示欄表示「可能會發生人身傷害或財產損失之預測內容」。

■ 以下將以圖示標示方式，區分及說明應遵守內容的種類。(以下為圖示標示例)



此圖示標示為「禁止」內容(請勿執行之事項)。



此圖示標示為「強制」內容(請務必執行之事項)。

■ 此冰箱使用可燃性的冷煤。以下的標示欄記載關於可燃性冷煤的注意事項。



此圖示標示為可燃性冷煤的注意事項。

警告

安裝時



- 針對地震等天然災害做好防止翻倒處置。
 - 避免因翻倒而受傷。



禁止淋濕

- 請勿設置於潮濕或會被水淋到的場所。

- 避免因電氣絕緣不良而引起觸電、火災的危險。



電源及電源電線



禁止

- 使用時請勿高於插座或配線器具的額定電流。

請勿使用交流額定電壓以外的電源。

若與其他電器插頭併用，或使用三面插座等，會因異常發熱而造成火災的危險。

- 請單獨使用額定電流 10A 以上的插座。



禁止

- 請勿讓電線、插頭破損。

請勿讓電線受損、加工、接近發熱器具、勉強彎曲、扭曲、拉扯、乘載重物、讓冰箱壓住電線或捆綁電線。

在已受損的狀態下使用時，會引發觸電、短路、火災的危險。

- 電源線損壞時，須由製造廠商或其服務處或具有相關資格的人員加以更換以避免危險。

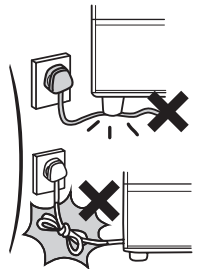

- 將插頭的電線向下，將插頭確實插入插座內。

· 如果插頭方向相反插入，會給電線增加負擔，成為短路、觸電、起火的原因。

· 如果插頭插得不夠完全，也將會成為因觸電，發熱而導致火災的原因。

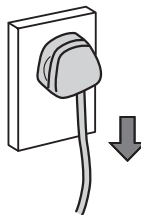

禁止濕手

- 請勿用潮濕的手，拔除插頭。

· 會引起觸電。

- 本電器不能在沒有人員監督以及指示之下，讓體力、知覺、以及精神不健全的人獨自操作(包含小孩)。並請注意以及隨時監督切勿讓小孩玩耍本電器。



警告

電源及電源電線



- 請定期清除插頭上的灰塵。當插頭堆積灰塵時會因濕氣而造成絕緣不良，進而引起火災。
· 請拔除插頭再用乾布擦拭乾淨。

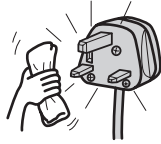

- 進行冰箱保養，請務必拔掉插頭。有觸電或受傷的危險。
28頁
· 請將插頭確實的從插座內拔出。

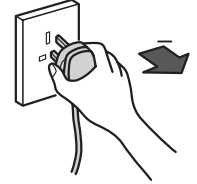

在一般使用的情況下



禁止淋濕

- 請勿用水淋濕主體與箱內。
· 避免因電氣絕緣不足而引起觸電·火災。



禁止

- 請勿放入容易引火的物品。
· 揮發油·乙醚·LP瓦斯·稀釋液·黏著劑會發生引爆的危險。

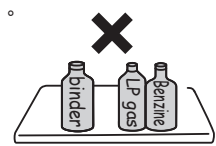

禁止淋濕

- 請勿將含水容器放在冰箱上。
· 翻倒的水會造成電氣組件絕緣不良而發生漏電·火災·觸電的危險。



禁止

- 在附近請勿使用可燃性噴霧用品。
· 避免因箱門開關等電氣接點引起的火花引發火災。



禁止

- 請勿在冰箱上放置物品。
· 避免因開閉箱門，造成物品掉落而受傷。



禁止

- 請勿用來保存藥品或學術試樣。
· 必須嚴格管理的物品，不可保存於家庭用冰箱內。



禁止接觸

- 請勿手觸自動製冰機的機械部位。
· 製冰盤旋轉時，手恐怕會受傷。



禁止

- 請勿懸在箱門上嬉戲，或踏在收納盒上。
· 避免因翻倒，夾到手指而受傷。



- 請注意不要讓孩子們玩耍。



禁止

- 請不要拆卸冰箱內燈的蓋子。
· 燈泡損壞時，須由製造廠商或其服務處或具有相關資格的人員加以更換以避免危險。

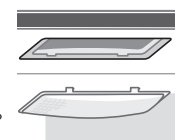

禁止

- 不要將箱門開得過大或靠在打開的箱門上等給箱門施加勉強的力。



禁止

- 不要用力碰撞門。



警告



關於冷媒（由於這是一種可燃性的氣體 R600a: 異丁烷，請注意以下的事項。）



禁止

- 不可以螺絲等銳利物品刮傷冰箱本體。由於使用可燃性的冷媒，當冷媒從冰箱內壁的配管外洩，會有起火、爆炸的危險。

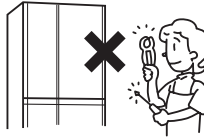

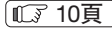
- 安裝的時候，在周圍要離開一些間隙，確保有足夠的散熱空間。  10頁 若冷媒外洩的情況持續，會有起火、爆炸的危險。

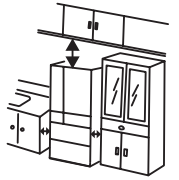

- 請勿損傷冰箱的冷卻管路。冷媒配管損壞時，請將冰箱遠離火源並避免使用電器用品。

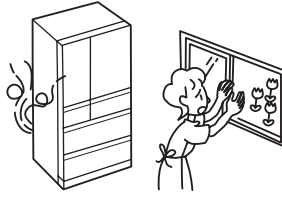

- 如需進行廢棄處理時，請聯絡經銷商或環保署資源回收中心專線，交給他們進行專業處理。若冷媒外洩會有起火、爆炸的危險。



禁止

- 除廠商建議方法外，不得使用機械工具或其它工具來加速除霜的過程。

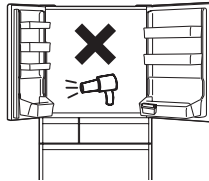

禁止

- 請勿在冰箱內部使用電器用品。
• 如冷媒外洩，電氣接點所產生的火花，會有起火、爆炸的危險。

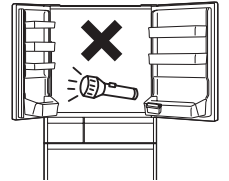

R600a

- 警告標籤和銘牌必須一直牢固張貼於壓縮器上和冰箱上。

萬一有下列情形



- 當產品異常或故障時，請拔掉插頭停止運轉。有觸電或受傷的危險。
• 請務必在拔除插頭時握住插頭。

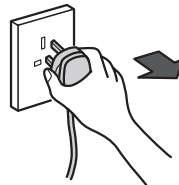

禁止分解

- 請勿自行分解、修理、改造。避免發生火災，異常動作而受傷。
• 需分解、維修時，請洽經銷代理商。



- 可燃性氣體外漏時，勿接觸冰箱，請立即開啟窗戶進行換氣。
• 避免因箱門開關等電氣接點的火花，而發生引爆、火災、燙傷等危險。



廢棄處理時



- 在等待廢棄物再利用保管之際，因有幼兒被誤困在箱內之虞，請將門墊拆下來。



⚠ 注意

移動・搬運時



禁止

- 請勿在容易刮傷的地板上使用冰箱滑輪。避免因滑輪而刮傷地板。
 - 請在容易刮傷的地板上鋪上保護板。
- 請勿以吊車吊起手把部位。
- 請勿碰撞冰箱背面・側面。

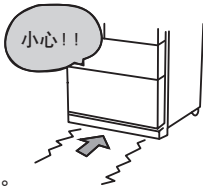

- 搬運時，請用手持手把搬運。倘若沒有手持把手，可能會因手滑而受傷。
 - 請僱用 2 人以上手持手把搬運。
 - 搬運時請如圖示般將箱門朝上。
 - 請不要用起重機等吊起把手。
 - 為了防止電源插頭、電線下垂，請以膠布固定。

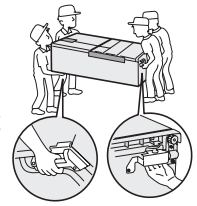

在一般使用的情況下



禁止

- 請勿在超大瓶飲料的縫隙間再塞入其他瓶罐。
 - 勉強放入超大瓶飲料瓶後，在開閉箱門時，可能會因掉落而受傷。



禁止

- 請勿讓食品凸出層架。
 - 避免因鉤到瓶罐後掉落而受傷。

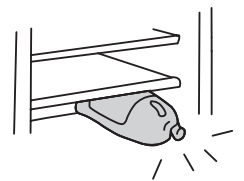

禁止

- 請勿將瓶子放在冷凍室內。
 - 內容物結凍會使瓶子破裂，容易受傷。

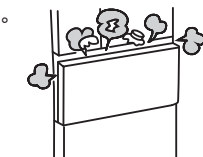

- 同時開啟二個以上的箱門時，或者其他人也在碰觸冰箱時，請確認手指是否會被冰箱門夾住。
 - 避免手指被門與門之間的縫隙所夾傷。



禁止

- 關抽屜型的箱門時，請勿手持上方推進。
 - 按住門上方關抽屜會夾住手指容易受傷。

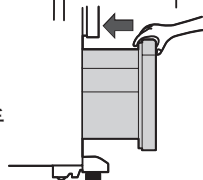

禁止

- 請勿用潮濕的手碰觸冷凍室內的食品或容器。
 - 避免凍傷。(尤其是金屬製品)



禁止

- 開啟最底層的箱門時，請勿讓腳靠近冰箱。
 - 避免在開啟箱門時，碰觸到腳底而受傷。



禁止

- 請勿食用有異味，已變色的食品。
 - 避免因食品腐敗而引發疾病。



禁止

- 手腳不要放進冰箱的底部。
 - 清理時將手伸入冰箱底部時，可能會被鐵板割傷。

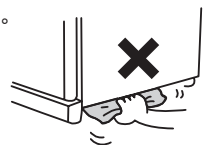

禁止

- 請勿用膝蓋去按電動抽屜的開關。
- 請勿把瓶子之類的物品放在電動抽屜附近。



禁止

- 請勿施加強烈撞擊力於玻璃層架及玻璃隔板。(可能因玻璃層架及玻璃隔板破裂而導致受傷)



禁止

- 請勿在玻璃層架及玻璃隔板的玻璃面上加熱，或放置熱的物品。



禁止

- 如果有人人在冰箱前，操作電動冷藏室門時，可能會因撞到打開的冷凍室門，而造成意想不到的傷害，請格外注意。



禁止

- 存放食物於活動式萬用盒時，請切勿重疊置放、勿超出層架、容易溢出的食品請密閉保存。



- 為了防止水滴到地板上。長時間門與冰箱間有縫隙時，結露水或除霜水可能會滴下。請確實關緊冰箱門讓門與冰箱之間沒有縫隙。



- 因為玻璃層架很重，安裝、拆卸時請格外注意。

確認事項

各室的名稱・存放食物

冷藏室 → 14頁
約 2°C~6°C

冷藏食品



箱門置物架附近溫度會稍高。

真空冰溫室 → 16頁
約 -1°C~約 1°C

肉類・魚類等的生鮮食品
利用真空與光觸媒的效果，抑制鮮度降低。





製冰室 → 20頁
約 -20°C~-18°C

收納自動製冰機所製造的冰塊。

上段・下段冷凍室
→ 18頁
約 -20°C~-18°C

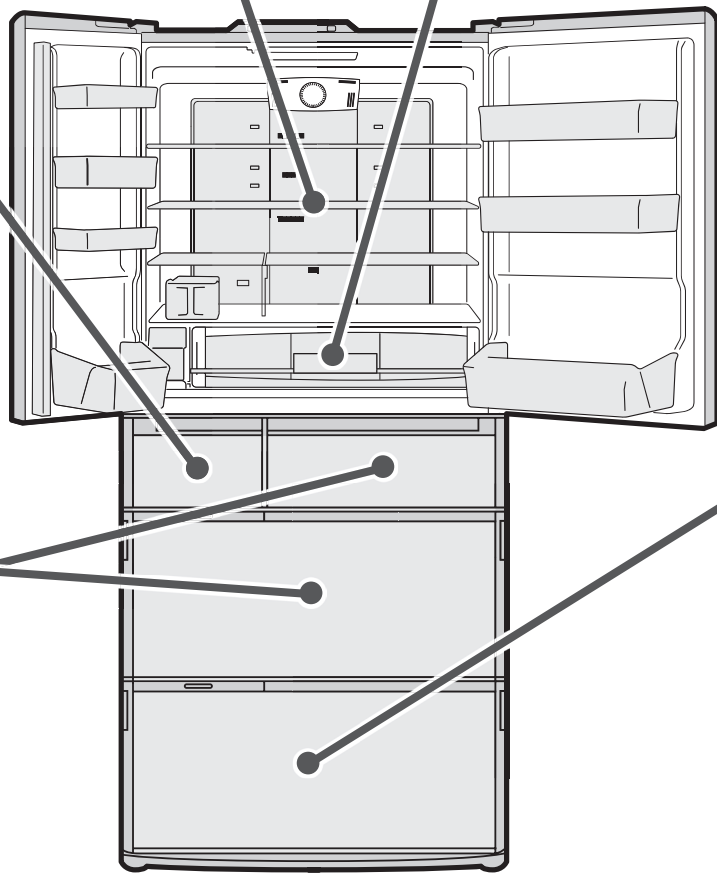
冷凍食品，
冰淇淋及乾貨。



蔬果保鮮室
→ 22頁
約 3°C~7°C

蔬菜，水果，飲料

上層存放空間
使用過的蔬菜、小型蔬菜、水果等



豎放儲存區
較高大的蔬菜及 2 公升的寶特瓶



豎放儲存區的溫度較高。

蔬果睡眠保鮮空間
葉菜類 (菠菜、小松菜等)、
大型蔬菜 (高麗菜、
高苜等)



- ※ 是在環境溫度 30°C、不放食物、關著門、安定時的標準值。
- 收納時請保留食品間的空隙。
- 建議您在存放強烈氣味食物時，先以保鮮膜包覆之後再放入冰箱。

附屬品

保證書	維修時請出示保證書
專用工具 (付調整墊 2 個)	請在固定冰箱時使用 → 10頁



操作面板的功能

操作部是玻璃觸碰式。

按下 **MENU** 按鍵時可以顯示目前的設定。
操作面板的上方是顯示部，下方是操作部。
請按操作部來切換各種設定。

注意事項 ● 若要切換設定時，請在冷藏室門關閉的狀態下操作。

確認事項

告知之顯

ECO	減少電力消耗，啟動運轉時顯示燈亮燈 → 24頁
Key	操作面板按鍵鎖，上鎖時顯示燈亮燈 → 25頁 告知異常時，顯示燈閃爍 → 36頁
Auto Door	電動冷藏室門功能「開」亮燈 → 12頁 ※ 只有 R-E6800X 型號
Auto Drawer	電動抽屜功能「開」亮燈 → 13頁
Water	當給水槽中的水減少時，顯示燈亮燈 → 21頁

※ 為了更清楚說明，所有的顯示都呈燈亮的狀態。

節電設定

節電模式的設定
將各室的冷卻減弱，節省電力。

Trip (旅行) → 24頁

Save (節電) → 24頁

溫度設定

設定冰箱各存放空間的溫度。
平常請設定在「■■■」的位置。

冷藏室 → 15頁

冷凍室 → 19頁

製冰設定

設定製冰模式

Quick (急速製冰) → 21頁

On (製冰) → 20頁

Off (製冰停止) → 21頁

設定冷卻模式

設定冷卻模式

Fridge (急冷藏) → 15頁

Freezer (急冷凍) → 19頁

Veg (蔬果室強) → 23頁

真空冰溫室設定

設定真空冰溫室模式

-1°C → 17頁

+1°C → 17頁

顯示燈全滅燈 → 17頁

最初碰觸 MENU 鍵

通知事項

- 關於顯示部
 - 請在所有冰箱門關閉的狀態下操作各種設定。當冰箱門開啟時或顯示部的顯示燈閃爍時，操作各種設定則無反應。
 - 要確認設定狀況時，請按下 **MENU**，或打開冷藏室門。顯示部會再次亮燈。
 - 操作結束後，再次按下 **MENU** 時，則顯示滅燈。沒有按下 **MENU**，為了達到省電目的，約 40 秒後顯示部及操作部也會滅燈。但「節電」模式的設定及「Fridge」「Freezer」「Quick」運轉時的顯示及「Off」「Water」的通知顯示，環保運轉的「eco 運轉顯示」則不會滅燈。
 - 開啟冰箱門若顯示部及操作部亮燈，冰箱門關閉後約 15 秒顯示文字則滅燈。
- 關於操作部
 - 觸控面板會根據周圍的溫度、濕度、使用者的身體狀態及旁邊的電器製品的使用狀況，其反應會有所變化。
 - 按了也沒有反應（顯示內容不變）的時候，請把手指離開一下再按。在兩次按鈕之間的間隔過短有可能導致檢測出錯誤訊息（感應為持續按）。用力按也不會改善感應度的。
 - 玻璃觸碰部濕或髒了的時候，會沒有反應。請以乾布擦拭。

事前準備

使用前的準備

1

設置在以下的場所

- 堅固・水平的地板
地毯・榻榻米（日式草蓆地板）・木板地・塑膠地板等恐怕會有變形・變色的可能，請墊（超過1cm厚）的板材。
- 避免陽光直射和高溫
- 不潮濕・空氣流通的地方
這些可防止冷卻功率下降，避免電費增加。而且可抑制變色以及生銹。
- 與其他的電器間隔一段距離
防止對電視等造成雜音或影像不安定等情形。
- 為了保持良好冷卻效率，在周圍請空開充分的散熱空間。
- 本體側面的中央部分是比所表示的尺寸稍大。
設置時請確保充裕的空間。
- 背面可靠牆設置。若有振動音或是不願讓牆壁弄髒及變色的話，請空開一些間隙。

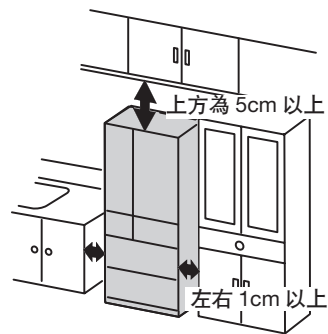

2

固定冰箱

旋轉冰箱前方下側的調整腳，來調整冰箱平衡。（請使用附屬專用工具及 2 個調整墊）

- 1** 手持遮蔽架的兩端，用力拉向身前卸下。

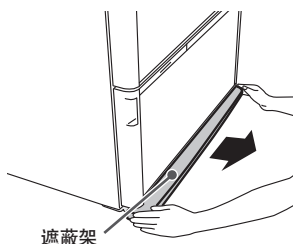

- 2** 將調整墊放在調整腳的下方。請將調整腳調整至前後左右平衡的狀態。

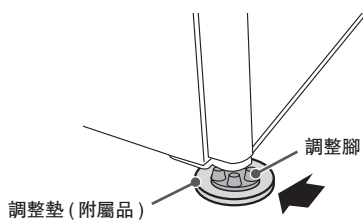

- 3** 旋轉降低調整腳，以固定冰箱。（左右兩個地方）請使用專用工具配合調整腳的形狀夾住調整腳。

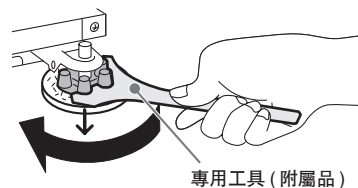

- 在放入調整墊之前，請將調整腳的底部與地板擦拭乾淨。若有髒污時將有可能會刮傷地板。
- 旋轉調整腳時，請使用專用工具並請注意勿傷及地板。

3

箱門的平衡調整

- 設置的地方不平，地板太軟，加上食物的重量，冰箱腳會下沉，箱門會稍有歪斜。
→ 機能上沒有問題，如介意請按如下的步驟進行平衡調整。
進行左右水平調整，並使冰箱的前側稍微高一點可方便關門以避免門沒關好。

- 1** 請使用附屬的專用工具調整箱門下沉一方的調整腳，直到左右冰箱門平行為止。
調整腳的旋轉量是，每旋轉 1 圈相當於箱門的高低差距 1mm。

■ 左側下歪

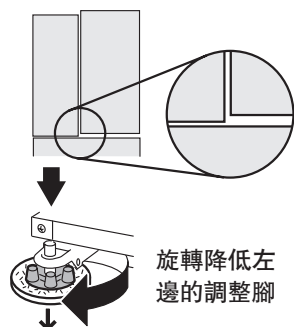

■ 右側下歪

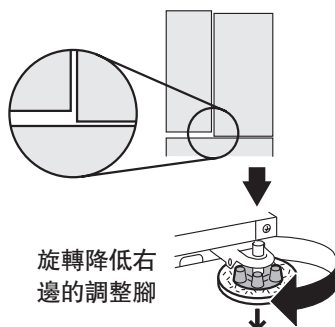

- 2** 請將遮蔽架的卡榫（左右）插入冰箱的安裝孔內安裝

調整後，冰箱本體與地板的適應需要約 5 天的時間。經過一段時間後冰箱仍無法平衡時請再次按步驟進行調整。

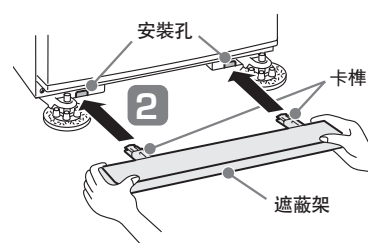

- 通知事項** ● 當冰箱門在開啟的狀態下，放開手時，門有可能會動，這並不是故障。

4

撕下真空冰溫室內的抗氧化益鮮盒上的標籤

使用前請撕下安裝在真空冰溫盒前的抗氧化益鮮盒上的標籤。

- 若沒有撕下標籤，則無法釋放出抗氧化成分及芥子精萃。

注意事項

- 請勿水洗。
- 請勿直接聞氣味。會有刺激的氣味。

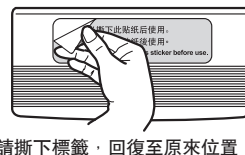
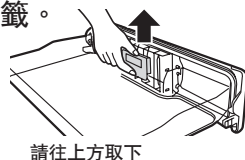

5

將電源插頭插入

設置後直接就可插上電源插頭。

請用獨立的插座。(電源 220 ~ 240V 額定電流 10A 以上)

- 請確認電源插頭及電線是否夾在冰箱背面及牆壁中間。為了防止電線發熱。

冰箱內開始冷卻

- 根據冰箱周圍溫度、食品的存放方式不同，冰箱內充分冷卻約需要 4 小時。夏天天氣炎熱時，也有可能需要 24 小時以上。在冰箱尚未充分冷卻前請勿將冰淇淋或未充分冷卻的食品、易受損的食品，放入冰箱。
- 初次使用自動製冰時，請操作自動製冰機的清潔「製冰機清潔」。[→ 30頁](#)
- 自動進行連續的製冰運轉是必須在冰箱內充分冷卻之後才能開始。
(初次使用時，最初的結冰可能需要花 24 小時以上。)

通知事項

- 插入電源插頭之後，為了確認冷氣風扇葉的狀態，冷氣風扇葉會持續動作約 2 分鐘。
(比平常冷氣風扇葉的動作聲音稍大，這不是異常現象)
- 剛開始適用時可能會有些許塑膠的氣味。請保持室內通風良好。使用後此氣味不久後即消失。

注意事項

- 若有硫化氣體噴出的溫泉地區等設置時，可能有必要進行配管的防銹處理，請預先與經銷店洽商。此外，氣體造成的故障是不屬於保修範圍以內。
- 請勿將背面的標籤撕下，或拆卸側面的導風蓋。
- 磁鐵裝飾或是吸盤吸附在冰箱本體或冰箱門表面有可能會留下痕跡。

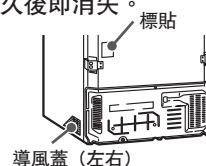

6

打開電動冷藏室門 ※ 只有 R-E6800X 型號

當插上電源插座後，觸碰電動冷藏室門操作部，電動冷藏室門則開啟。[→ 12頁](#)

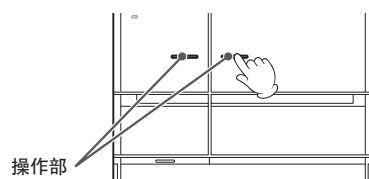

移動・搬運的事前準備 (搬家時)

1

將食物及冰塊取出

2

將給水槽、製冰盤的水倒掉

3

拔除電源插頭
要搬動之前拔除即可

4

拆除冰箱遮蔽架，將調整腳升高

5

以膠布將冰箱門・電源線固定

6

移動・搬運時請鋪上保護用的鋪墊或布
防止刮傷地板、或冰箱內部殘留水流至地板。

7

在地板上鋪上鋪墊或布，將冰箱往後傾倒，讓內部的水流出



8

搬運時請握住搬運把手搬運，並請 2 人以上進行搬運

運輸時請勿將冰箱橫放。
(冰箱故障的原因)

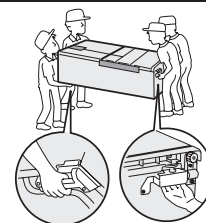

9

在預定放置的位置，請依照「使用前的準備」的指示進行設置。[→ 10頁](#)

電動冷藏室門

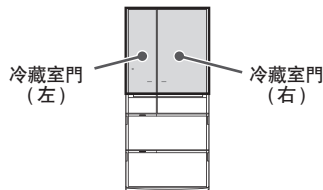

使用電動冷藏室門功能，只要以手指輕輕觸碰，即可輕鬆地開啟冷藏室門。(只有 R-E6800X 型號)

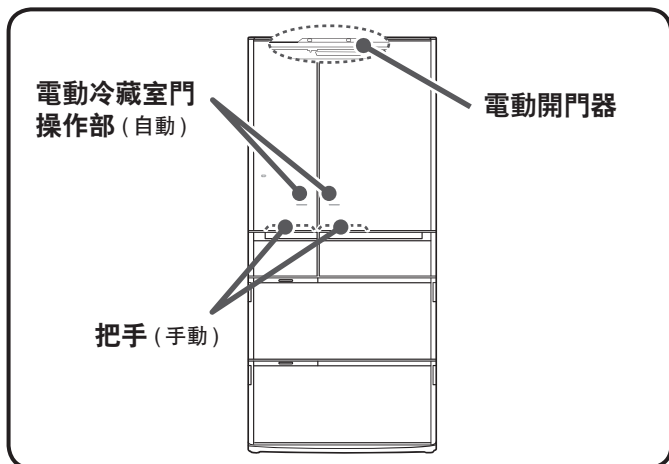

注意

- 如果幼兒可能玩弄電動冷藏室門時，請停止使用電動冷藏室門功能。
- 電動冷藏室門的操作部以手指操作。
- 如果有人人在冰箱前，請勿操作電動冷藏室門。(可能會因撞到打開的冷藏室門，而造成意想不到的傷害)
- 要清理電動冷藏室門時，請務必將電源插頭從插座拔除。
- 冰箱上面請勿放置物品。

設定電動冷藏室門

1

按下操作面板的 **MENU** 按鍵，顯示燈亮

顯示燈全部燈亮後，顯示目前的所有設定。

2

持續按住 **Fridge** 3 秒，直到發出設定音為止

電動冷藏室門的功能可切換成「開」或「關」。

出廠時，設定為「Auto Door」顯示(燈亮)的狀態。

要停止電動冷藏室門的功能時，請設定為「關」。



電動冷藏室門的功能	「開」(電動冷藏室門操作部可以使用)	「關」(電動冷藏室門操作部不可使用)
「Auto Door」的顯示	燈亮 Auto Door	熄滅
設定音	嗶 -	嗶嗶

通知事項

- 當電動冷藏室門設定為「關」時，請以把手開啟冷藏室門。
- 無法將「冷藏室門(右)」或「冷藏室門(左)」單一邊停止冷藏室電動門功能。

使用電動冷藏室門

當觸碰電動冷藏室門操作部，發出操作音，門自動開啟。

關閉時，以手握住把手把關閉冷藏室門(沒有電動功能)

電動冷藏室門的開啟方式	開啟單一邊冷藏室門	從冰箱上方的俯視圖	一次開啟兩邊的冷藏室門	從冰箱上方的俯視圖
操作方法	觸碰開啟的冷藏室門的操作部		以手指在操作部的一端滑動到另一端(依順序開啟操作的冷藏室門)	
電動冷藏室門的操作音	嗶		嗶 -	

通知事項

- 電動冷藏室門的目的是為了減輕開啟冷藏室門的負擔所設計的功能。隨著冰箱的設置條件、冰箱門置物盒內飲料食品的收納狀況，電動冷藏室門開啟的角度可能有所改變，或在開啟之後會稍微關閉的情形，這並非故障。
- 「製冰室」、「上層冷凍室」的任何一個在開啟的狀態下時，電動冷藏室門則無法操作。
- 當碰觸電動冷藏室門操作部後，冷藏室門在開啟的動作時會發出聲音，這並非異常。
- 當電動冷藏室門的操作部濕或髒時，有可能冷藏室門沒有反應。請以沾濕的布將污垢擦拭之後，再以乾布擦拭乾淨。
- 同時觸碰電動冷藏室門操作部周邊，持續約 1 秒以上時，冷藏室門有可能無法開啟。

電動抽屜

使用電動抽屜功能，縱使存放了許多食品，重量相當重，也能輕輕鬆鬆的取出。

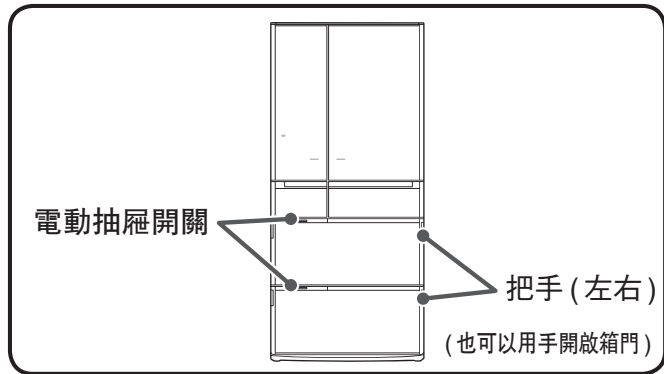
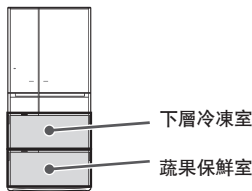

注意

- 如果孩童可能玩弄電動抽屜，可以停止電動抽屜功能。
- 請勿握持箱門把手以外的部分關閉箱門（可能造成因冰箱門夾住手指而受傷的情形）
- 當你按下蔬果保鮮室的電動抽屜開關時，腳請勿靠近冰箱。（避免開啟箱門時撞到腳而受傷）
- 用手操作電動抽屜開關。
- 務必先拔下電源插頭，然後再維修電動抽屜。

設定電動抽屜

1

按下操作面板的 **MENU** 按鍵，顯示燈亮

顯示燈全部燈亮後，顯示目前的所有設定。

2

持續按住 **Freezer** 3 秒以上，直到發出設定音為止

電動抽屜的功能可切換成「開」或「關」。

出廠時，設定為「Auto Drawer」顯示（燈亮）的狀態。

若要停止電動抽屜功能時，請將設定切換為「關」。

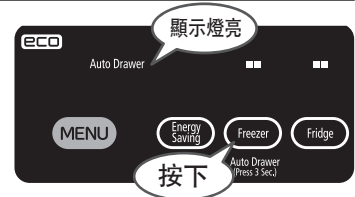

電動抽屜的功能	「開」（可使用電動抽屜的開關）	「關」（無法使用電動抽屜的開關）
「Auto Drawer」的顯示	燈亮 Auto Drawer	熄滅
設定音	嗶 -	嗶嗶

通知事項

- 當電動抽屜設定在「關」時，請拉左右的把手打開抽屜。
- 「下層冷凍室」或是「蔬果保鮮室」，無法只停止任何一方的電動抽屜功能。

使用電動抽屜

用手按下電動抽屜開關，抽屜就會開啟。

關閉時，請以手動將左右把手推進。

（關門不是電動操作。）

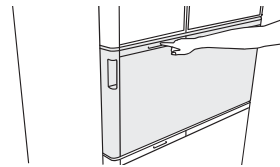

通知事項

- 為了減輕拉出抽屜時的負擔所設計的功能，開始動作時，推出抽屜的尺寸約在 15cm 以上。因冰箱設置條件不同，有可能拉出抽屜的尺寸稍微不同，或是門以電動的方式開啟後又稍微退回，這些都不是異常現象。
- “下層冷凍室”和“蔬果保鮮室”不能同時用電動開啟。
- 當“下層冷凍室”和“蔬果保鮮室”中任何一方被開啟，電動抽屜功能將不能操作。
- 當你按下電動抽屜開關時，可聽見聲響。這不是異常。
- 電動抽屜功能在「關閉」或是停電時，無法啟動電動抽屜功能。
- 電動抽屜按鍵上若沾上食品液體時，請立即擦拭乾淨。會造成電動抽屜按鍵機構部的故障，或是抽屜門無故地開啟的原因。

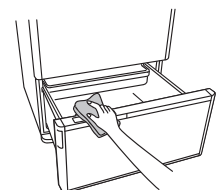

冷藏室

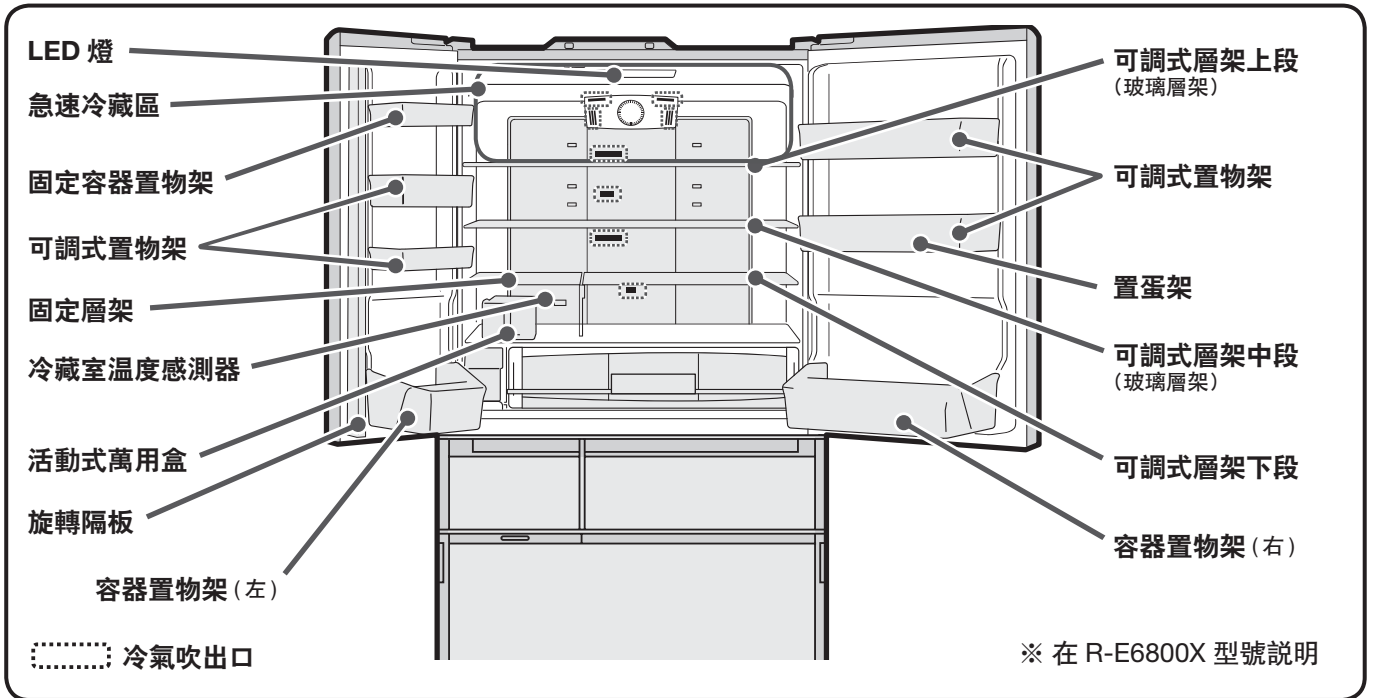
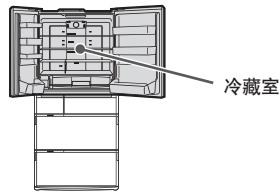

注意事項

- 將含水份較多的食物或罐裝飲料放置在冷氣吹出口附近時，有可能因結凍而導致破裂的情形。
- 稍有熱度的食物請放置在急速冷藏區或可調式層架。若將食品放置太靠近溫度感測器時，冷藏室溫度會過低，而導致冷藏室內側面板有結露的產生。
- 請勿將箱門開得過大或靠在打開的箱門上等給箱門施加勉強的力。箱門有可能会损坏。

調整置物架・層架的高度

配合食品或飲料的大小，置物架及層架的位置可以做適度的調整。

關於拆卸方式・安裝方式請參閱 → 32頁

■ 可調式置物架

■ 可調式層架 (上段・中段)

配合食品及飲料的高低可以做適度的調整。

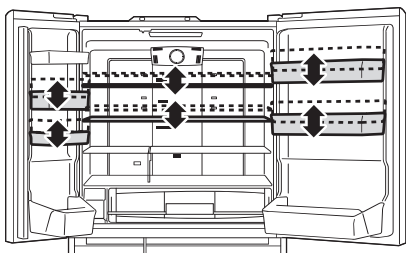

■ 可調式層架 (下段)

調節可分為 3 個階段。

● 剛出廠時的狀態

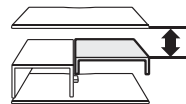

● 收納鍋子等

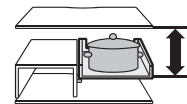

● 收納紙盒裝牛奶等

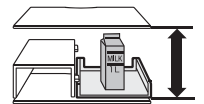

注意事項

- 請勿對玻璃層架施加強力的撞擊。(可能造成玻璃層架的破裂)
- 因玻璃層架較重，安裝，卸除時請特別小心。

注意

■ 開門時

- 請勿握住旋轉隔板部開啟冰箱門。(可能造成冰箱門無法開啟)



■ 關門時

- 當旋轉隔板立起的狀態時請勿關閉冰箱門。(可能造成冰箱門無法完全關閉)

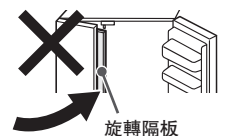

使用活動式萬用盒

放入雞蛋等食品，可以在冷藏室內自由選擇保存位置。

可以存放 10 個雞蛋。
市售雞蛋盒可以直接放入。

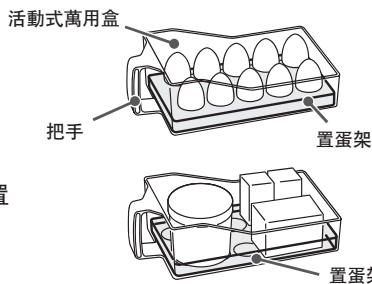

可將置蛋架翻轉，可以用來放置小型的食品。

注意事項

- 移動時請緊握把手。
- 因食物可能會落下，請勿將食品重疊存放。
- 因食物可能會傾倒，請勿放入過高的食物。
- 請不要用此容器來製冰。有可能造成容器的破損。
- 在冷氣出風口處放置水份較多的食品、罐裝飲料、雞蛋等，可能因結凍而破損。請放置在離冷氣出風口稍遠的位置。

調節冷藏室溫度

1 按下操作面板的 **MENU** 按鍵，顯示燈亮

顯示燈全部燈亮後，顯示目前的所有設定。

2 按下 **Fridge** 按鍵，可以變更適當的溫度

按下按鈕時依如右圖所示順序切換。
出廠時設定為「■■■」。

- 通常請使用「■■■」的位置。溫度因使用條件而有所變動。
- 調節更細微的溫度時 → 27頁

通知事項

- 設定改為「■■■■」或「■」時，真空冰溫室的溫度也會稍微改變。
 - 箱門層架比右圖所示溫度略高。
- ※ 是在周圍溫度30°C、不放入食品、關閉冰箱門、安定的狀況下的冷藏室的大致溫度。

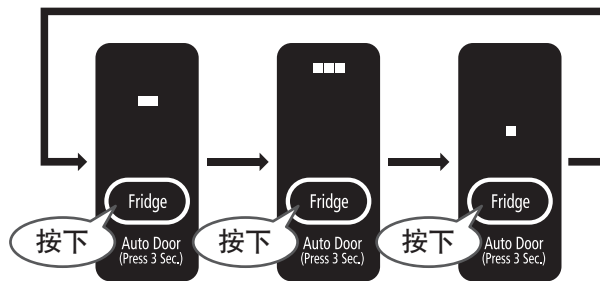

急速冷卻食品 (急冷藏)

1 在急速冷藏區放食物

放在中央的內側部分可較快冷卻。(冷氣吹出口前面)

注意事項

- 罐裝飲料及水份較多的食品請離背面冷氣吹出口一段距離置放。有可能會結凍、破裂。

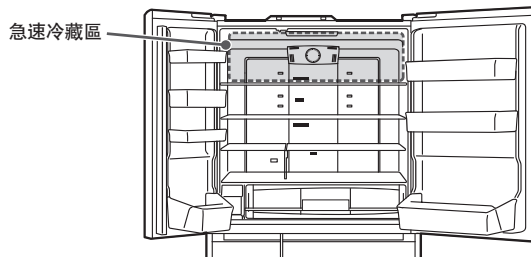

2 按下操作面板的 **MENU** 按鍵，顯示燈亮

顯示燈全部燈亮後，顯示目前的所有設定。

3 按下 **Powerful** 按鍵「Fridge」顯示燈亮

「Fridge」在運轉中時「Fridge」的顯示燈亮燈，其餘的顯示在 40 秒後即熄滅。
約 50 分鐘運轉後自動停止，此時「Fridge」的顯示燈熄滅。

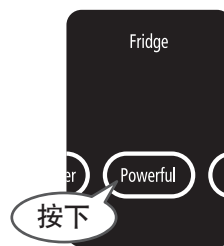

中途解除 按下操作面板的 **MENU** 按鍵，顯示燈亮

按下 **Powerful** 按鍵「Fridge」顯示燈熄滅

真空冰溫室

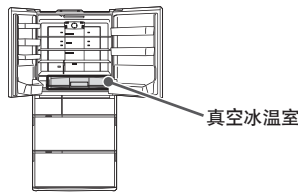

光觸媒及 LED 燈

利用 LED 燈光與光觸媒的效果，將食品中產生味道的成分及蔬菜所產生的乙烯氣體轉換成碳酸氣，抑制酵素的活性。LED 燈光除了具有光觸媒功能之外，打開冷藏室門時，可照亮真空冰溫室

真空幫浦

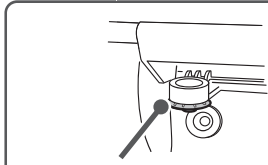

真空解除閥 (藍色)

向上提起把手解除鎖定，藉由真空解除閥可以解除真空狀態。解除真空時會有「咻」的聲音。

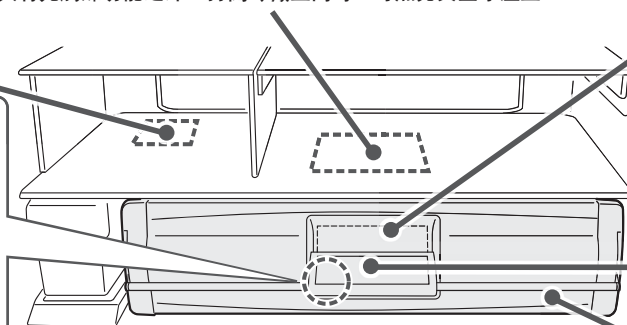

抗氧化益鮮盒

使用前請務必將標籤撕下。

→ 11頁

真空冰溫室內呈真空狀態，會從容器內釋放出抗氧化成分及芥子精萃，以保持食品的鮮度及營養素。
※ 不需要定期更換。

把手

真空冰溫盒
(付鋁製托盤)

開閉真空冰溫室門

開啟箱門時

1

將把手往上扳起，解除鎖定

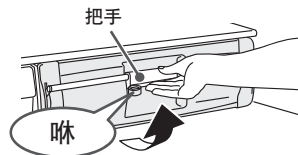

2

將真空冰溫盒往前拉出

當「咻」的聲音還響著時，因為是真空狀態，真空冰溫盒是不能打開的。當的聲音消失時，握住把手往身前方向打開箱門。

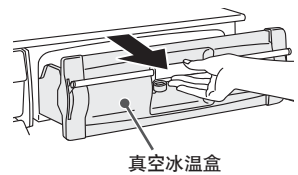

注意事項

在沒有同時開啟左右冰箱門的狀態下拉出真空冰溫盒時，可能造成零件的破損。

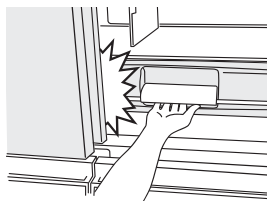

關閉箱門時

1

將真空冰溫盒往內推進

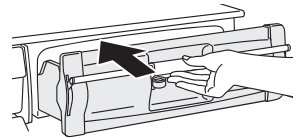

注意事項

在真空冰溫盒開啟的狀態下，關閉冷藏室門時，有可能造成零件及食品的破損。

2

將把手往下扳，讓其鎖定

往下按把手鎖緊。如果沒有壓到最底部時，則真空冰溫功能無法正常啟動。

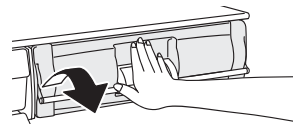

注意事項

在尚未鎖定把手的狀態下關閉冰箱門時，可能造成零件破損及密封墊裂縫。

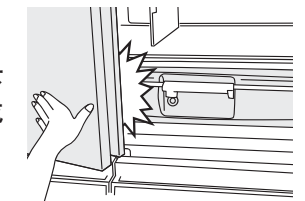

通知事項

- 關閉真空冰溫盒，鎖緊把手，再關閉冰箱門時，此時則啟動真空幫浦。
- 開始啟動真空幫浦時，會有發出聲音，這不是異常的情形。
- 啟動真空幫浦至真空狀態，約需 3 分鐘的時間。在 3 分鐘以內縱使打開真空冰溫室門也有可能不會有“咻”的聲音，因此要確認真空狀態請等到 3 分鐘以後再行確認。
- 真空冰溫室是利用間接冷卻的原理，與其他冷藏室比較之下，食品至完全冷卻需要花較久的時間。
- 周圍照明變暗時，可以透過冰箱門的密封墊隱約看見光觸媒正在運作及 LED 燈光。

敬請依照指示操作

- 抗氧化益鮮盒若有髒汙時，請用擰乾的濕布擦拭乾淨。

注意事項

- 請勿以水清洗抗氧化益鮮盒。萬一水洗時，請讓其充分乾燥後再使用。
- 請勿直接在抗氧化益鮮盒上面施加以有氣味的物品。可能造成刺激性的氣味。
- 請勿分解抗氧化益鮮盒。

變更真空冰溫室的設定

1 按下操作面板的 **MENU** 按鍵，顯示燈亮

顯示燈全部燈亮後，顯示目前的所有設定。

2 按下 **Vacuum** 按鍵，可依照個人喜好變更設定

按下按鈕時依下列的順序切換。出廠時設定為真空冰溫。

注意事項 ● 為達到省電目的，約 40 秒顯示燈即熄燈，所設定的功能將持續有效。

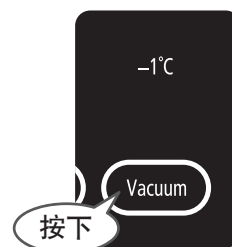
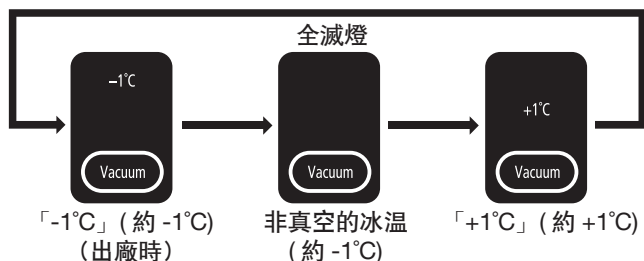

※ 周圍溫度 30°C 沒有放入食物，冰箱門關閉的狀態，在安定時的真空冰溫室的約略溫度。

真空冰溫室

設定與存放食品

真空

-1°C
(約 -1°C)

存放下列的食品時，請設定為「-1°C」。

- 肉類・加工肉品
- 魚貝類・海鮮類・魚類加工食品



冷凍的肉類、魚類要解凍時，也請設定為 -1°C 狀態。
含水分較多的食物有可能會凍結。

存放下列的食品時，請設定為「+1°C」。

- 乳製品
- 結凍時會造成品質、口感變差的食物



優格・起司等



豆腐・蒟蒻・油炸豆腐・白絲蒟蒻・水煮蛋等

- 切好的蔬菜、水果



生菜沙拉・紫蘇葉等的新鮮蔬菜・柳橙・奇異果等的水果

- 其他



放入密封袋・容器的蔬菜・咖啡豆・茶葉等

真空關閉

全滅燈
(非真空的冰溫)
(約 -1°C)

真空功能・光觸媒功能停止運作。建議存放需裝在「密封袋」、「密封容器」的食物時選擇該模式。因為是一般的「-1°C」冰溫室，含水分較多的食物可能因低溫而凍結。

儲存時需要注意的食品與容器

- 密封袋包裝食品

密封袋在儲存時可能會膨脹而擠壓到其他食品。



維也納香腸・乳酪片等。

注意

- 塑膠密封容器

塑膠密封容器的蓋子在儲存時可能會鬆開或脫離原來的位罝。取出時請注意。



注意

不適於儲存的食物

- 不耐低溫的蔬菜

低溫可能會使得蔬菜表面變質。請收納在蔬果保鮮室。



茄子 小黃瓜
黃秋葵・蘆筍・生薑・青椒

通知事項

- 縱使食品以保鮮膜包覆，也不會改變真空的效果。

注意事項

- 周圍溫度低時，水分較多的食物可能因低溫而凍結。
- 將冷藏室・冷凍室的溫度設定調至「■■■■」或是「■」時，真空冰溫室的溫度會稍有改變。

敬請依照指示操作

因為真空冰溫室是密閉的狀態，食品和空氣中所含的水分，有可能在冷凍室內結成水滴或結霜。

- 若有水滴或結霜時，請以柔軟的布沾溫水擦拭。
 - 真空冰溫室內若水或食品的液汁溢出時，請立刻擦拭乾淨。
- ※ 產生水滴或結霜並不會對冷卻性能造成影響。

水滴・結霜



冷凍室

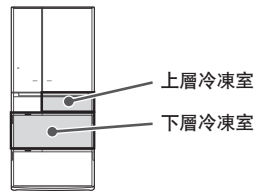

使用上層冷凍室

急速地冰凍將鮮味密封的急速冷凍機能。 → 19頁

請使用於急速冷凍肉類或魚類時。

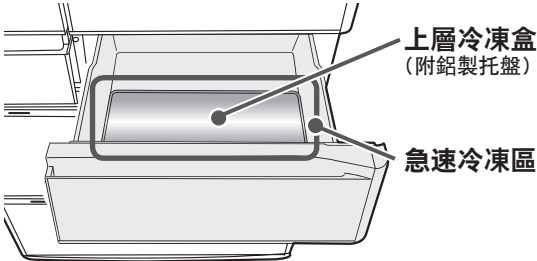

收納食品

上層冷凍盒	冷凍包裝、密封容器等 可當作小件冷凍食品的存放空間
	急速冷凍區 在短時間內冷凍肉類、魚類時

使用下層冷凍室

內配 3 層冷凍盒，能夠充分地存放，整齊地收拾。

適於存放需長期保存的東西，容易融化的冰淇淋等。

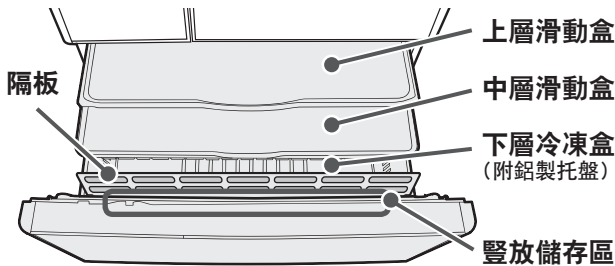

●將上層冷凍室的鋁製托盤往上層滑動盒左側移動，便可作為急凍區使用。

注意事項 ● 請勿拆下上層滑動盒與隔板。

收納食品

上層滑動盒	小件物品，冷凍食品等
中層滑動盒	冷凍包裝，密封容器等
下層冷凍盒	冷凍食品，麵包，冰淇淋等 豎放儲存區 存放冷凍專用寶特瓶等

食品收納時請格外注意

請注意每個盒子所能容納的食品高度。

可能因箱門沒有完全關緊，而造成不夠冷的情形。此外，也可能造成食品、盒子破損的情形。請勿讓上部的上層滑動盒或是中層滑動盒的底部接觸到其他食物。

約略高度

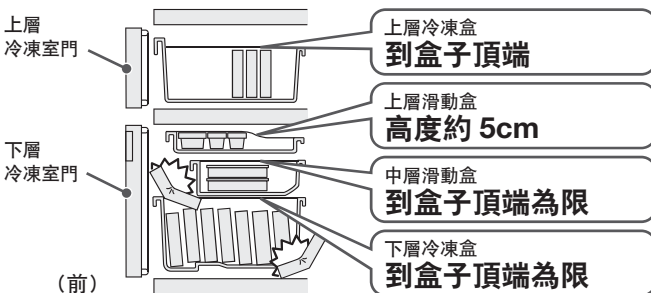

- 上層滑動盒裡請勿存放 500mL 的塑膠瓶。塑膠瓶凍結後會膨脹，導致中層滑動盒拉不出來。
- 請勿將中層滑動盒拆下。食品會掉落到下層冷凍盒的後面，導致門無法關緊。

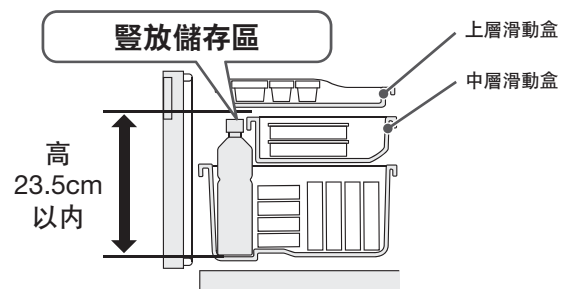

- 在豎放儲存區裏儲放高的食物時，請注意不要碰到上層滑動盒及中層滑動盒。
- 請只使用於存放冷凍對應的寶特瓶類及能夠冷凍的食品。

調節冷凍室的溫度

1 按下操作面板的 **MENU** 按鍵，顯示燈亮

顯示燈全部燈亮後，顯示目前的所有設定。

2 按下 **Freezer** 按鍵，可依照個人喜好變更設定。

按下按鈕時依如右圖所示順序切換。

出廠時設定為「■■■」。

※ 是在環境溫度 30°C、不放食物、關著門、安定時的標準值。

● 通常請使用“■■■”的位置。溫度因使用條件而有所變動。

● 操作部分的詳細使用方式 → 27頁

注：冷凍室「■■■■」（低溫冷凍）是比平常冷凍還要低溫的狀態來保存食物。與平常冷凍時的運轉相比，消費電力約增加 20%。

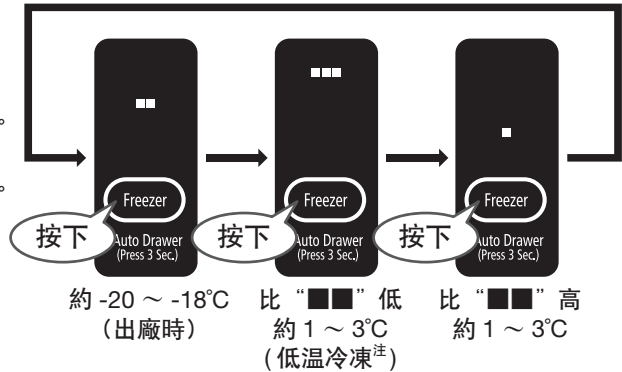

通知事項

● 冷凍室「■■■■」長時間使用時，冰淇淋等會變硬、儲存的食品的解凍時間會變長。

冷凍室

將食品急速冷凍 (急冷凍)

1 上層冷凍室的鋁製托盤上放用保鮮膜包好的食品

將食品分開小塊、薄片，不但能快速冷卻到中心部，而且方便取出。

通知事項

● 將上層冷凍室的鋁製托盤移至下層冷凍室的上層滑動盒左側，可做為急速冷凍區使用。

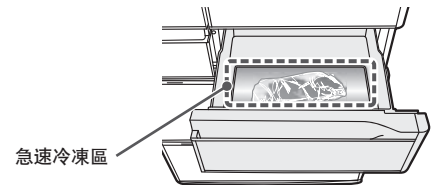

2 按下操作面板的 **MENU** 按鍵，顯示燈亮

顯示燈全部燈亮後，顯示目前的所有設定。

3 按下 **Powerful** 按鍵「Freezer」顯示燈亮

「Freezer」在運轉中時「Freezer」的顯示燈亮燈，其餘的顯示在 40 秒後即熄滅。

約 120 分鐘運轉自動結束，「Freezer」顯示自動熄滅。

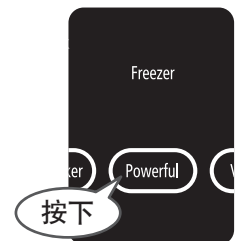

中途解除

按下操作面板的 **MENU** 按鍵，顯示燈亮，
再按下 **Powerful** 按鍵「Freezer」顯示燈熄滅

通知事項

- 「Freezer」中，為了優先冷卻冷凍室，特別是冷藏室的門開關頻繁的時候，冷藏室的溫度容易升高。
- 可以直接冷凍熱的飯等。放入熱的食品時，會有燙傷的危險，請注意！建議冷卻到可以用手拿的溫度之後再放入。
- 「Freezer」結束後的 60 分鐘以內，再次按 **Powerful** 鍵時，雖然「Freezer」顯示燈亮，但「Freezer」不運轉。60 分鐘過後才恢復運轉。
- 為了防止食品粘在鋁製托盤上，請務必包上保鮮膜。

製冰室 (自動製冰機)

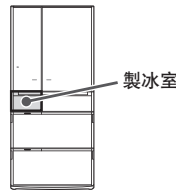

給水槽
(約 1.0 公升)

操作部

儲冰盒

製冰室

自動製冰機

製冰方法

- 1 按下操作面板的 **MENU** 按鍵，顯示燈亮**

顯示燈全部燈亮後，顯示目前的所有設定。
- 2 按下 **Ice Maker** 按鍵，顯示燈亮**
- 3 取出給水槽**

「Water」亮起，或是水量已經接近「給水線」時請補充水。
- 4 打開給水槽蓋加水**

加到滿水線。
※ 請勿加水至滿水位以上。
- 5 再裝回給水槽**

往前推入到超過「水槽安裝位置」的線位。
給水槽必須推至比水槽安裝位置更裡面，才會進行給水。
※ 給水槽傾斜會將水灑出。
水灑出請立即擦乾。

自動開始製冰運轉

冰塊儲存在儲冰盒中。
一次製冰約可製 12 個冰塊。

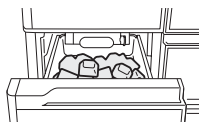

通知事項

下列的情形時，可能會延長製冰的所需時間。

- 開始使用時 (可能需要 24 小時以上)
- 設定成「節電」模式時
- 冰箱門開關次數頻繁時
- 冰箱內同時放進大量食物時
- 停電時
- 冬天周圍溫度較低時
- 清潔製冰盤後
- 冷凍室或製冰室門呈半開的狀態
- 冷凍室溫度設定為「■」時

初次製冰時、或是一星期以上沒有製冰時，請操作「製冰機清潔」。[→ 30頁](#)

敬請依照指示操作

- 注意：只可加入飲用水。
- 製冰用水根據貴國的飲用水標準而定。
自來水的水質因不同國家而異。
請向地方當局檢查、核實。
- 因衛生上的理由，請至少每週更換一次水，並清洗容器。
- 使用含豐富礦物質的礦泉水製作冰塊時，會產生白色的粉末，這是礦物質成分，對人體無害。
- 如下列所示，因為容易受到細菌污染，平常請三天清洗容器一次。

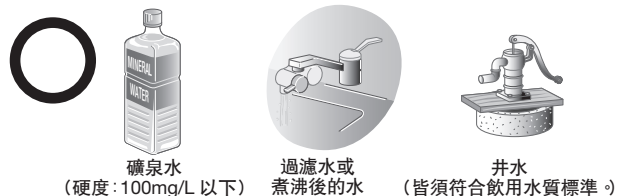

- 由於會導致故障，或是會造出畸形、連體的冰等，請不要使用這些 (液體)。



急速製冰

1 按下操作面板的 **MENU** 按鍵，顯示燈亮

顯示燈全部燈亮後，顯示目前的所有設定。

2 按下 **Ice Maker** 按鍵，「Quick」顯示燈亮

比「On」更縮短製冰時間。
一次製冰約可製 12 個冰塊。

「Quick」運轉時，「Quick」的顯示亮燈。
其他的顯示約在 40 秒後滅燈。

約 7 小時「Quick」的運轉則自動停止，切換至「On」模式。



製冰停止

1 按下操作面板的 **MENU** 按鍵，顯示燈亮

顯示燈全部燈亮後，顯示目前的所有設定。

2 按下 **Ice Maker** 按鍵，「Off」顯示燈亮

自動製冰停止。

※ 一星期以上「Off」時，自動製冰機則需進行清潔。

→ 30, 31頁

通知事項

- 「Off」的顯示燈不會熄滅。



告知給水警示燈

給水槽的水量減少時，「Water」顯示燈亮。請補充水至給水槽內。

- 當「Water」亮燈時，縱使設定在「On」或「Quick」時也無法製冰。

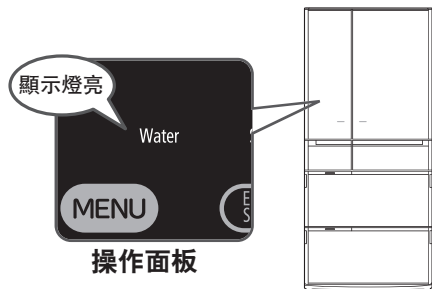

通知事項

- 「Water」燈顯示燈亮的狀態下開啟冰箱箱門時，「Water」會滅燈（最長會熄滅 3 小時），若沒有補充水時則會再次燈亮。
- 自動製冰機設定為「Off」時，「Water」不會顯示燈亮。

注意事項

- 即使給水槽中有水，但是安裝給水槽時沒有確實推入，「Water」會顯示燈亮。此時請確實地將給水槽往前推入至固定位置。

「On」顯示為閃爍時

製冰盤有可能碰到製冰盒內的食物。



敬請依照指示操作

請先將製冰盒內清空，再操作「製冰機清潔」。

→ 30頁

- 自動製冰設定時，儲冰盒中請勿放冰以外的冷凍食品等。（會造成不能製冰、食品碰到製冰機的部件、門打不開、部件損壞的情況。）

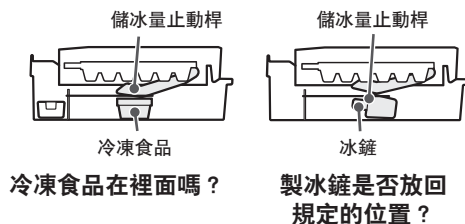

儲冰盒的冰塊收納量・製冰時間

冰的收納量	正常運轉	約 120 個
	將冰塊整平	約 150 個
一次的製冰時間	通常的「On」	約 110 分 ~ 140 分
	「Quick」	約 80 分

※ 周圍溫度 30°C，各冰箱的溫度設定在「■■」的位置，無開關冰箱門狀態的約略值。

通知事項

- 滿水線表示的是冰塊平放在冰盒中時的最大容量。
如果冰盒內只有一部分冰塊，但是冰塊碰到了止動桿，即使冰塊數量很少，製冰機也會停止製冰。

敬請依照指示操作

- 請小心開關製冰室門。
若太用力開關製冰室門時，冰塊可能從儲冰盒掉到下層冷凍室。

蔬果保鮮室

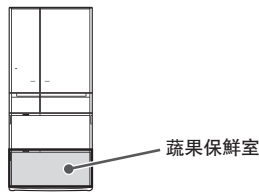

蔬果保鮮室

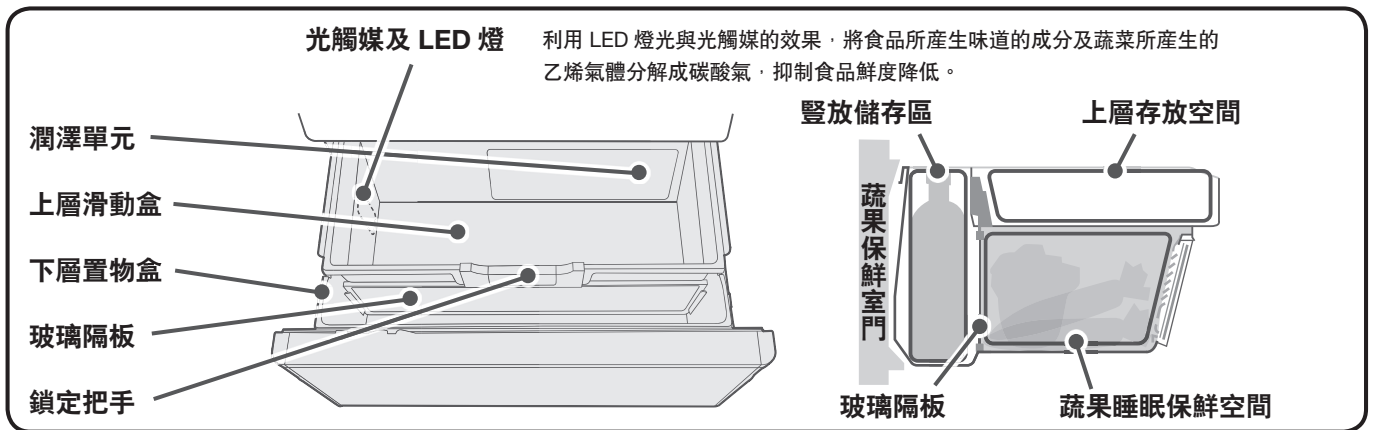

- 注意事項**
- 請勿拆卸下層置物盒的潤澤單元及光觸媒。
 - 不得拆下玻璃隔板。

收納食品

上層存放空間	使用過的蔬菜、小型蔬菜、水果等
豎放儲存區	較高大的蔬菜及 2 公升的寶特瓶
蔬果睡眠保鮮空間	葉菜類 (菠菜、小松菜等)、大型蔬菜 (高麗菜、萵苣等)



- 敬請依照指示操作**
- 蔬果保鮮室內濕度高，因存放的蔬菜數量及種類不同，可能上層滑動盒、下層置物盒、蔬果保鮮室頂板及食品表面會有結露情形，這不是異常現象。特別是蔬果睡眠保鮮空間內的濕度更高，可能有更多的結露情形。水份聚集時容易讓食品受損，請以軟布擦拭。
 - 可能因食品包裝袋及容器阻塞潤澤單元，會發生更多的結露情形。請將阻塞在潤澤單元的食品包裝袋及容器移至其他地方。
 - 如果擔心結露，請用保鮮膜包裹食品。
 - 將米、海苔等乾燥食品存放在蔬果保鮮室時，請放置於密閉的容器 (袋) 內。乾燥食品容易吸收濕氣。

食品收納時請格外注意

請注意每個盒子所能容納的食品高度。

可能因箱門沒有確實關緊，而造成不夠冷的情形。此外，可能造成食品、盒子破損的情形。請勿將食物碰觸到上層滑動盒的底部。

約略高度

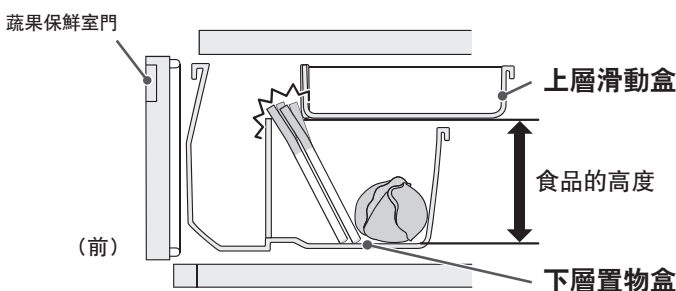

- 請勿存放食品超過置物盒的高度。
 - 可能因箱門沒有確實關緊，而造成不夠冷的情形。
 - 可能造成食品、盒子、玻璃隔板破損的情形。
 - 若上層滑動盒沒確實關緊，則會失去睡眠保鮮效果。
- 請勿將食品、飲料等硬塞入豎放儲存區。
 - 因寶特瓶的種類不同，有可能過大而至無法收納。
 - 請勿將食品、飲料等硬塞進去。可能會造成玻璃隔板的破損。

使用蔬果睡眠保鮮空間

打開時

1

押住上層滑動盒中央的鎖定手把，推向裡面。

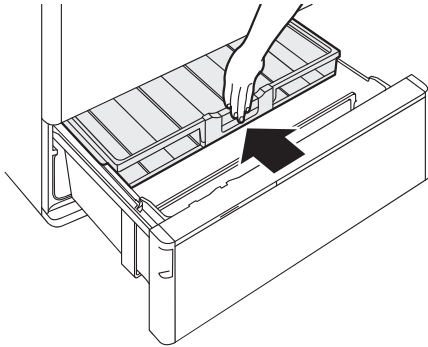

注意事項

- 若沒押住鎖定手把，則上層滑動盒無法向裡面推進。

關閉時

1

往前拉上層滑動盒中央的鎖定手把，直到發出「卡幾」聲，即鎖定。

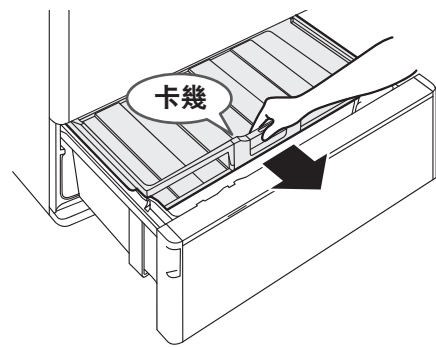

- ※ 關上蔬果保鮮室門時，上層滑動盒會回到原來的位位置且鎖定。

若想以更冷的溫度來保鮮時（蔬果室強）

1

按下操作面板的 **MENU** 按鍵，顯示燈亮

顯示燈全部燈亮後，顯示目前的所有設定。

2

按下 **Powerful**，「Veg」的顯示燈亮

以比平常更低的溫度來保存。（平常約 3 ~ 7°C → 「Veg」約 1 ~ 5°C）

※ 是周圍溫度 30°C，在不放入食品關閉冰箱門，安定運轉時的蔬果保鮮室的大致溫度。

注意事項

- 為了達到省電目的顯示在 40 秒後即熄燈，此設定將持續進行直到解除為止。

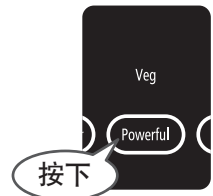

解除

按下操作面板的 **MENU**，顯示燈亮後，

再按下 **Powerful** 「Veg」的顯示燈熄滅

通知事項

- 長時間使用「Veg」功能時，含水分較多的蔬菜有可能會結凍。請解除「Veg」的設定。
- 「Veg」與「Freezer」「Fridge」無法同時設定。在「Veg」模式中，切換成「Freezer」「Fridge」之後，「Freezer」「Fridge」自動停止運轉時也不會自動回復到「Veg」模式，請再次設定。
- 在「Veg」模式中，設定成「節電」模式的情形時，冷卻效果會由「Veg」轉向較弱的冷卻效果。→ 24頁
- 當外面氣溫低時，置物盒內溫度可能會變低。
- 豎放儲存區比其他存放空間溫度稍高。

敬請依照指示操作

- 茄子、小黃瓜等比較不耐低溫的蔬菜，當設定為「Veg」時，可能造成蔬菜表面凹陷、變色的情形。若有這樣情形請解除「Veg」的設定。
- 設定為「Veg」時，蔬果睡眠保鮮空間內的結露量會增多。若擔心結露請解除「Veg」的設定。

不耐低溫的蔬菜



各種功能

「節電」模式的設定

設定成節電模式 (「Save」·「Trip」) 時，將切換成以下的運轉方式，節省電力。

「節電」模式	Save	將各冷藏室的冷卻調弱，可達到省電目的。 長時間持續開啟冰箱箱門時 (30 秒以上)，冷藏室的 LED 燈及真空冰溫室的 LED 燈及蔬果保鮮室的 LED 燈的亮度會減弱，以節省用電。 ※ 設定為「Save」模式時，其節電功能持續進行，直到解除設定為止。
	Trip	慢慢地降低冰箱內的溫度，比「Save」更能節省消費電力。 (請在旅行等長期外出時設定此功能) ※ 設定為「Trip」後，一旦開關門後即切換為「Save」。

1

按下操作面板的 **MENU** 按鍵，顯示燈亮

顯示燈全部燈亮後，顯示目前的所有設定。

2

按下 **Energy Saving** 按鍵，可依照個人喜好變更設定

按下按鈕時依下列的順序切換。

出廠時，設定成節電模式「關」(全滅燈)的狀態。



通知事項

- 「Save」模式與「Trip」模式、「Quick」(約 7 小時)、「Freezer」(約 120 分鐘)、「Fridge」(約 50 分鐘)，同時設定時，冷卻效果以「Quick」、「Freezer」、「Fridge」優先，運轉結束後，回復到「Save」、「Trip」模式。(→ 15, 19, 21頁)
- 「Save」模式與「Trip」模式、「Veg」同時設定時，冷卻從「Veg」轉變到較弱的冷卻效果。(→ 23頁)
- 「冷凍室」「冷藏室」的溫度設定在「■」的時候，為了維持食品的新鮮度，冷卻效果不轉弱。

注意事項

- 將冷卻轉換為弱的時候，冰淇淋等會變軟、冷凍食品有可能會結霜。此外讓食品冷凍的凍結時間以及製冰時間也會增長。

eco 運轉顯示燈

霜能再利用時，減少電力消耗，自動顯示燈亮燈，告知冰箱是處在省能源運轉狀況。

通知事項

〔eco 運轉顯示燈〕無法燈亮時，可能是以下的原因。

- 剛設置完成後、或一次儲放大量的食品時
- 冰箱門開閉次數頻繁時
- 當食品或包裝袋被箱門夾住，而箱門關不緊時
- 設定為「Freezer」「Fridge」「Quick」「Veg」時
- 冰箱周圍溫度達到 35°C 以上時



操作面板鎖定功能

是為了防止誤觸操作面板，及兒童玩弄冰箱而設計的功能。

「」(按鍵鎖)的顯示燈亮燈時，即使按了其他的操作部也無法切換。

1

按下操作面板的  按鍵，顯示燈亮

顯示燈全部燈亮後，顯示目前的所有設定。

2



持續按住  3 秒以上，直到發出設定音為止

操作面板按鍵鎖可切換「開」或「關」。

出廠時，設定成「」(熄滅)的狀態。

操作面板按鍵鎖的設定	「開」(鎖定中)	「關」(解除鎖定)
「  」顯示	燈亮 	熄滅
設定音	嗶—	嗶嗶

通知事項

- 雖設定為操作面板鎖定，但電動抽屜的功能也不會因而停止。
如果想要停止電動冷藏室門以及電動抽屜的設定時，請先解除操作部的鎖定，持續按住  或  3 秒以上直到發出嗶嗶聲音。 (→ 12, 13頁)
- 拔除電源插頭再插上插頭時，或停電後恢復供電時，有可能解除操作面板的鎖定。

箱門警報器

當冰箱門開啟長達 1 分以上時，會以如下表的聲音或顯示來告知冰箱門未關閉。

R-E6800 型號 的上層冷凍室沒有箱門警報器功能。

箱門的打開時間	1 分鐘後	2 分鐘後	3 分鐘後
警報音	嗶—(3 次)	嗶—(5 次)	嗶—(連續)大音量

※ 當箱門開啟超過 1 分鐘以上時，顯示部閃爍，操作部則亮燈。

※ 只有設定為節電模式時，當冰箱門開啟 30 秒後警聲才會響。(顯示部閃爍，則表示箱門開啟長達 1 分鐘以上)

※ 冰箱門警報器機能啟動中，顯示部閃爍時縱使按下操作部也沒有反應。

箱門警報器及操作音的音量調節

箱門警報器及操作音可設定為更大音量，也可以設定為靜音。

1

按下操作面板的  按鍵，顯示燈亮

顯示燈全部燈亮後，顯示目前的所有設定。

2

持續按住  3 秒以上，直到發出設定音為止

操作音的音量可切換成「標準」「大」「關閉」。設定的切換依照此順序輪替，請依個人需求切換設定音。(參照下表)

出廠時，設定成標準音量。

音量	標準	大音量	關閉音量	標準
設定音	—	嗶—嗶—	嗶—	嗶嗶

(出廠時)

通知事項

- 箱門警報器或操作音，無法只調整任何一方的音量。
- 設定為不會發出聲響時，冰箱門警報器的文字顯示燈的閃爍也停止。
- 雖音量設定為「關閉」時，「製冰機清潔」的警報器、電動冷藏室門「開」以及電動抽屜「開」的操作音也會發出聲響。
- 當拔除電源插頭再插上插頭時，或停電後恢復供電時，冰箱門警報音則恢復到原來的標準狀態的設定。

各種功能 (續前頁)

將防止結露的加熱器設定為弱 (旋轉隔板部・隔板鐵板部)

將防止結露的加熱器設定為弱時，可達到省電的目的。

當旋轉隔板及隔板鐵板部有結露時，請設定為標準模式。

旋轉隔板及隔板鐵板部的設定分為 1 至 4 階段，階段 4 最能達到省電目的。

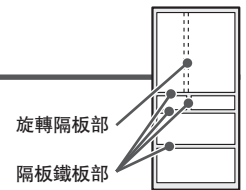

加熱器設定為弱	標準	弱設定 階段 1	弱設定 階段 2	弱設定 階段 3	弱設定 階段 4	標準
設定音	—	嗶—	嗶— (2 次)	嗶— (3 次)	嗶— (4 次)	嗶嗶

(出廠時)

旋轉隔板的設定

- 1 開啟下層冷凍室門
- 2 按下操作面板的 **MENU** 按鍵，顯示燈亮
顯示燈全部燈亮後，顯示目前的所有設定。
- 3 持續按住 **Powerful** 3 秒以上，直到發出設定音為止
防止結露加熱器設定為弱的階段將切換。
請重複上述的操作，設定所期望的階段 (參照上表)。
- 4 關閉下層冷凍室門

隔板的鐵板部的設定

- 1 開啟下層冷凍室門
- 2 按下操作面板的 **MENU** 按鍵，顯示燈亮
顯示燈全部燈亮後，顯示目前的所有設定。
- 3 持續按住 **Energy Saving** 3 秒以上，直到發出設定音為止
防止結露加熱器設定為弱的階段將切換。
請重複上述的操作，設定所期望的階段 (參照上表)。
- 4 關閉下層冷凍室門

通知事項

- 當拔除插頭再插入，或是停電恢復供電時，將會回復到標準設定。

溫度微調節 (冷藏室・冷凍室)

冷藏室和冷凍室的溫度設定可以更細分為 11 個階段。平常請使用在「■■■」的位置。

- 1 開啟下層冷凍室門
- 2 按下操作面板的 **MENU** 按鍵，顯示燈亮
顯示燈全部燈亮後，顯示目前的所有設定。
- 3 持續按住 **Fridge** 按鍵 5 秒以上，直到發出嗶聲為止
- 4 關閉下層冷凍室門
- 5 按下 **Fridge** 或 **Freezer** 按鍵，可調節各室的溫度。
按下按鍵，如下圖所示依序切換。

(□ 顯示燈亮 ■ 顯示燈閃爍 ■ 熄滅)

顯示											
設定	更弱	弱	→	→	→	中	→	→	→	強	更強

↑

解除 依照 1、2、3 順序操作

操作音「嗶嗶」響起，便回復到通常的調節 (3 階段)。

保養方法 〈定期檢查〉



警告

- 清掃時，請一定要把電源插頭從插座拔掉。

■ 發現骯髒時

- 立即擦乾淨。看不到的部分也請一年清掃一次。

電源插頭 一年1~2次

1

將電源插頭從插座拔掉

附著在電源插頭上的灰塵擱置而不清掃的話，會導致火災。

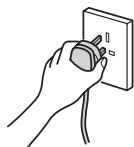

2

檢查

- 電線有損壞嗎？
- 電源插頭發熱嗎？
- ※ 如果發現異常時，請與購買的販賣店聯繫。

3

用乾布擦去灰塵等



4

將電源插頭確實插入插座上



箱門表面 一個月一次

箱門表面請以柔軟的布，沾溫水將污垢擦拭後，再用乾布擦拭乾淨。

玻璃表面殘留有膠布黏膠時，以塑膠橡皮擦擦拭之後，再以乾布擦拭乾淨。

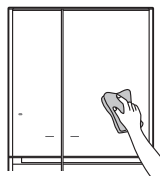

箱門密封墊 一個月一次

由於此部分容易髒，請擦乾淨。

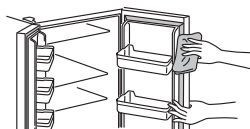

注意事項

- 因為可能會造成箱門、塗裝面、塑膠受損、變色，請勿使用以下的東西。
 - 鹼性和弱鹼性的廚房用洗潔劑、去污粉、肥皂粉、石油、熱開水、刷子、酸、揮發油、稀釋劑、酒精、漂白劑等等
 - (請確認洗潔劑上「根據家庭用品品質表示法表示」的「液性」欄)
- 若使用化學抹布時，請遵守其使用上的注意事項。
- 沾到食用油、柑橘類的果汁、食品液汁時，請務必擦乾淨。因為其可能引發箱門、漆面與塑膠部件的損傷與變色。
- 因置物盒或抽屜的滑動軌道接觸面上塗抹了潤滑劑，保養時請勿擦拭。
- 磁鐵裝飾或是吸盤吸附在冰箱本體的側面或冰箱門表面時，有可能會在表面留下痕跡。
- 拔除電源插頭時，會解除操作面板設定的功能，請再次確認設定。

冰箱背面・地板 一年1~2次

1

將遮蔽架往前拉出卸下

安裝時，從正面插入

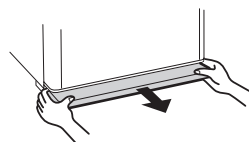

2

使調整腳浮起離開地面，將冰箱往身前筆直地拖出

若是容易刮壞的地板，則鋪上保護用的板等



3

擦乾淨背面・側面導管・牆壁・地板上的污垢

背面由於空氣對流的關係，容易堆積灰塵而弄髒。

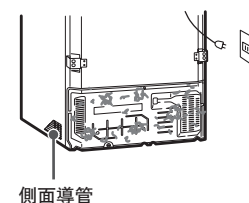

各層架・置物架・置物盒 三個月一次

請以軟布沾溫水擦拭。

卸除方法請參閱 → 32, 33頁

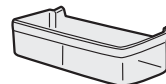

敬請依照指示操作

- 用水清洗蔬果保鮮室下層置物盒時，請倒轉讓水滴乾，並用乾布充分擦拭乾淨。此外請勿使用牙刷、洗碗刷等長刷毛的刷子清洗。可能會造成置物盒受損及潤澤單元破損。

液汁承接處 一個月一次

積著液汁時，請擦乾淨。

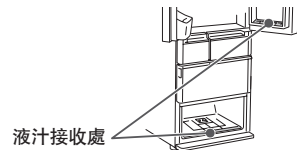

1 拉出真空冰溫盒

卸除方法請參閱 → 32頁
請務必取出保存在真空冰溫盒內食品。

2 卸除抗氧化益鮮盒 → 11頁

請以擰乾的濕抹布擦拭抗氧化益鮮盒。

3 以下的零件，請以沾溫水的軟布擦拭

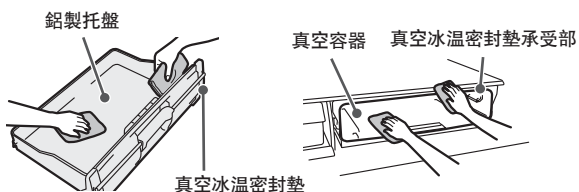

4 將抗氧化益鮮盒安裝在真空冰溫盒

5 安裝真空冰溫盒

安裝方式請參閱 → 32頁

注意事項

- 請勿以水清洗抗氧化益鮮盒。
- 真空冰溫室內上方的玻璃（光觸媒及 LED 燈光部分），請勿用手指觸摸或用乾布擦拭。沾有污垢時，請以沾濕的棉花棒輕輕擦拭除去污垢。
- 真空冰溫密封墊如果使用溫水以外的洗潔劑，則有可能破損、變形、變色，無法保持真空狀態。
- 如果真空冰溫密封墊鬆了或是接觸不良，則無法維持真空狀態。

真空冰溫密封墊污垢時

1 從真空冰溫盒取下真空冰溫密封墊

以手握住右上方的真空冰溫密封墊的突起，小心地拆下密封墊。

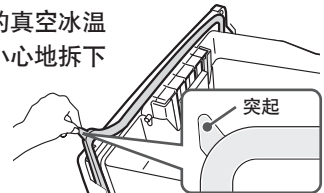

2 髒污的部分請以柔軟的海棉等清洗乾淨

※ 請勿使用洗潔劑。

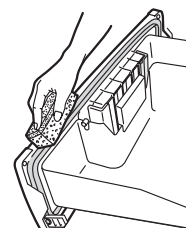

若真空冰溫密封墊安裝溝槽中有髒污請擦拭乾淨。

3 以乾布將水擦拭乾淨後自然乾燥

4 安裝真空冰溫密封墊

將真空冰溫密封墊的突起對準凹槽上的缺口，牢牢地固定。

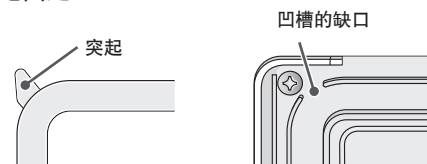

電動抽屜

當有食品掉在電動抽屜中，或卡在抽屜上方，以及液體沉積時，請清洗電動抽屜。

1 電源插頭一定要從插座拔掉

2 卸除下層冷凍室以及蔬果保鮮室各箱盒 → 33頁

3 請取出掉下而被夾著的食品等

4 請用柔軟的乾布擦乾積水

注意事項

- 請勿用水洗電動抽屜組件，會導致故障。
- 請勿拆卸電動抽屜組件，會導致故障及受傷。



警告

- 保養前請務必拔下電源插頭，以免受傷。



保養方法 (續前頁)



警告

- 請勿觸摸自動製冰機的機械部分。
(當製冰盤旋轉時，會有受傷的危險)

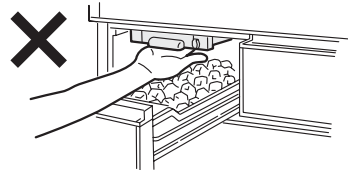

製冰機清潔

初次使用時

自動製冰機一週以上沒有使用時

準備

操作前請確認以下事項

給水槽

- 裝水至滿水線
- 超過儲水槽的安裝位置，正確的安裝。

儲冰盒

- 有殘留冰塊時請清除

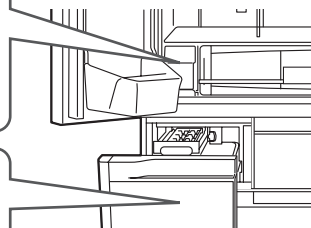

都確認完了之後請操作下一個步驟。

1

關閉所有的箱門

2

按下操作面板的 **MENU** 按鍵，顯示燈亮

顯示燈全部燈亮後，顯示目前的所有設定。

3

持續按住 **Ice Maker** 按鍵 5 秒以上，直到發出警示聲響為止

「Quick」·「On」·「Off」三個顯示閃爍，請在警示聲響了之後放開手指。

「製冰機清潔」(給水路清潔)便開始運作。(約 4 分鐘)

- 大約 4 分鐘之間，顯示閃爍、警報器會一直響。
- 操作「製冰機清潔」功能時在途中無法停止。
- 操作「製冰機清潔」功能當中，如果打開冰箱的任何一個門時，則有可能無法正常運作。請在製冰機清潔運作結束之前不要開啟冰箱門。
- 冰箱門警示聲設定在停止的狀態下警示聲也會發出聲響。 → 25頁

閃爍

Quick
On
Off

按下

Ice Maker
Cleaning
(Press 5 Sec.)

4

警示聲響及顯示燈閃爍停止後，塞住儲冰盒內部的缺口部分，在儲冰盒的底部鋪上乾淨的毛巾。

鋪上毛巾的主要目的是，清潔儲冰盒時存在於內部的水會從製冰盒裡面的缺口部分流出，鋪上毛巾來吸收流出的水。

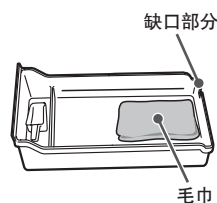

5

將儲冰盒內的水擦拭乾淨後安裝在製冰室內

卸除儲冰盒，將儲冰盒內的水擦拭乾淨後，請將毛巾等取出。

給水槽裡剩下的水，可以繼續直接使用。

「製冰機清潔」結束後，自動設定回「On」。



給水槽

一週一次

1

取出給水槽，卸除水槽蓋

請依照水槽蓋上前方的箭頭指示方向拿起即可卸除。

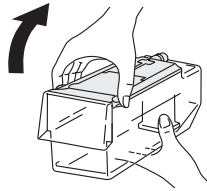

2

從水槽蓋取下密封墊圈及盒子

盒子由旋轉方式卸下來。

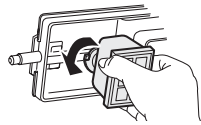

3

從盒子取下淨水濾片

以手指拉淨水濾網，從扣勾處卸下後再卸除箱盒。

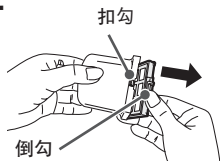

4

以水清洗給水槽各零件

以柔軟的海綿等用水洗乾淨。請不要使用洗潔劑等。

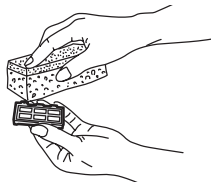

敬請依照指示操作

●為了防止淨水濾網長霉及黏性物質，請讓濾網充分乾燥。

通知事項

●更換的基準約3～4年。→ 38頁

5

將給水槽的各部零件組裝，加入水之後再安裝

請從水槽蓋的後方插入，往箭頭方向關上。

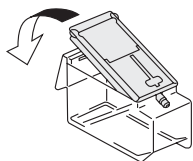

通知事項

- 礦泉水、井水、淨水器的水、冷開水等（不含氯元素的水），比自來水容易產生水垢、黏性物質，請3天清潔一次。
- 一週以上不使用自動製冰機時，請將給水槽充分乾燥後再安裝在規定的位置。（特別是淨水濾片請務必充分乾燥）此外，一週以上不使用自動製冰機，開始使用前請依照「製冰機清潔」操作。→ 30頁

製冰盤

一年1～2次

1

按下操作面板的 **MENU** 按鍵，顯示燈亮

顯示燈全部燈亮後，顯示目前的所有設定。

2

按下 **Ice Maker** 按鍵，「Off」顯示燈亮

停止往製冰盤給水。

※當「Off」閃爍時，約1分鐘待燈亮之後再進行以下操作。

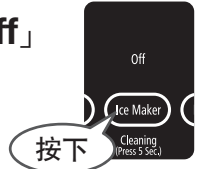

3

打開製冰室門，取出製冰盤

- 1 將扳手往橫的方向押。
- 2 拉出框架。
- 3 護蓋（▲部）往身前方向揭起
- 4 從框架裡取出製冰盤。

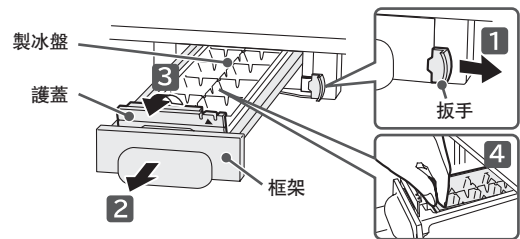

4

騰空製冰盤，用流水簡單沖洗。

請勿使用海綿，去污粉。
請勿刮傷表面。



5

打開製冰室門，安裝製冰盤

- 1 安裝製冰盤並關上。
- 2 關上護蓋，直到發出「卡噠」聲
- 3 將框架往裡面推進，直到發出「卡噠」聲（請前後搖動框架，確認是否緊實地固定住。）

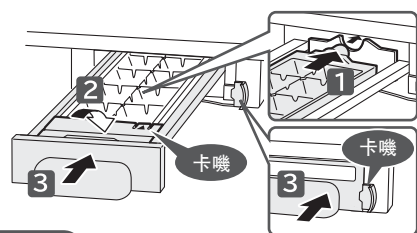

通知事項

●製冰盤的「框架推不到底」時，因為沒有設定「Off」，所以驅動製冰盤的馬達有可能已啟動。一旦卸除製冰盤，只將框架推入並關上所有的門，在按下 **Ice Maker** 按鍵，設定為「Off」。過了一段時間製冰盤的驅動馬達的準備完成後，便可安裝。

6

按下操作面板的 **MENU** 按鍵，顯示燈亮，再按下 **Ice Maker** 按鍵，「On」顯示燈亮

開始自動製冰

保養方法（續前頁）

卸除組件的方法 · 安裝的方法

注意事項

- 卸除零件時，請先將放在零件上的食品移除。
 - 請勿拆除此處未說明的零件。
- 想要卸除說明書上沒有說明的零件來清潔等時，請向技術中心諮詢。

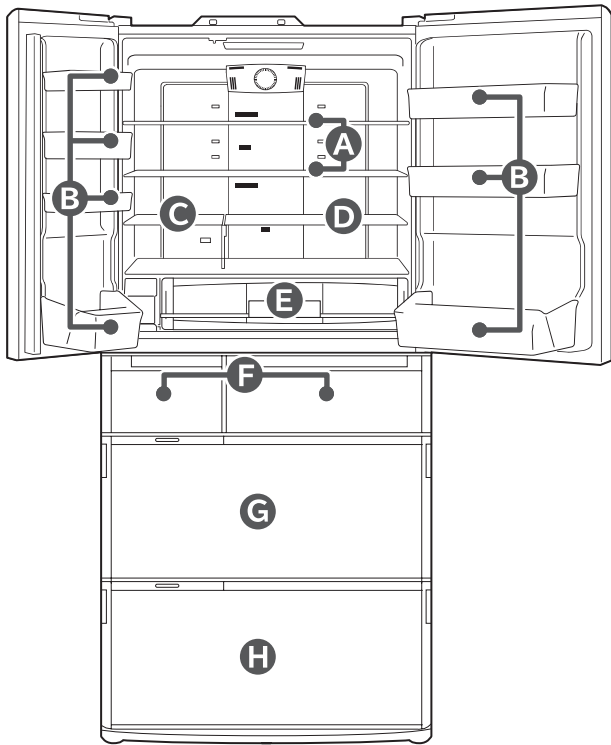

A 可調式層架上段 · 中段 (玻璃層架)

- 1 把層架內側稍微抬高，往前拉出。
- 2 如圖，將層架豎起後翻轉、卸除。

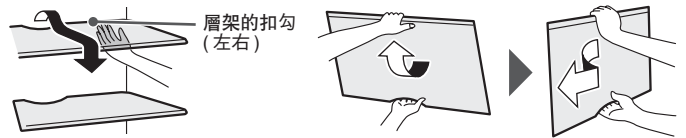

安裝時，把層架插放到最內側之後，把層架內側稍微抬高並推進去。(將層架的卡榫掛在最內側的配件上)

注意事項

直接把層架拉出有可能損傷箱門。
因玻璃層架較重，安裝、卸除時請特別小心。掉落時可能會被撞傷或是因破裂而被刮傷。

B 箱門置物架

一邊輕敲底部左右一邊提高便可卸取。
(牢固地固定)

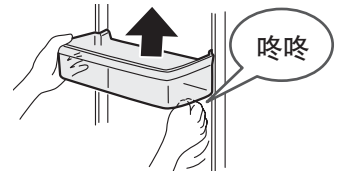

安裝時，請完全裝入到最底。

注意事項

如安裝不牢，會掉落，可能導致人員受傷。

C 固定層架

往前拉出來，將右下 2 處的扣勾拆開並取下。

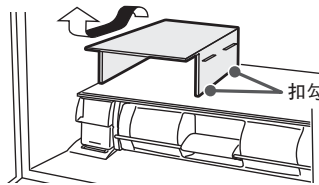

D 可調式層架下段

稍微抬高並取下。

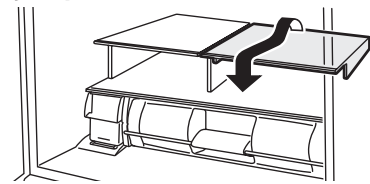

注意事項

往前方直接拉出層架時，有可能會刮傷冰箱門。

E 真空冰溫盒

卸除方法

拉出真空冰溫盒，往前方稍微向上抬起，上下搖動後拉出。

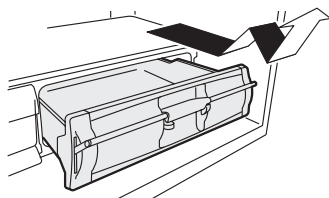

安裝方法

讓真空冰溫盒的左右突起順著真空容器的導引軌道滑動推入。

最後再將把手往下扳到底鎖住。

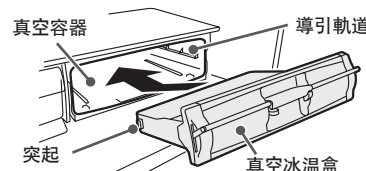

敬請依照指示操作

安裝後請數次拉出推進，確認是否正確安裝。

F 儲冰盒（製冰室）· 上層冷凍盒（上層冷凍室）

打開門，向前方取出。

安裝時要將箱底面裝載在框架上。

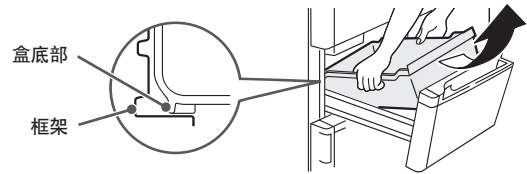

G 中層滑動盒 · 下層冷凍盒（下層冷凍室）

1 打開門後，拉出中層滑動盒。

2 向上取出下層冷凍盒。

注意事項 ● 請勿拆下上層滑動盒。

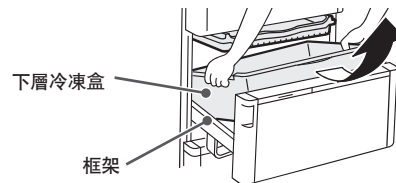
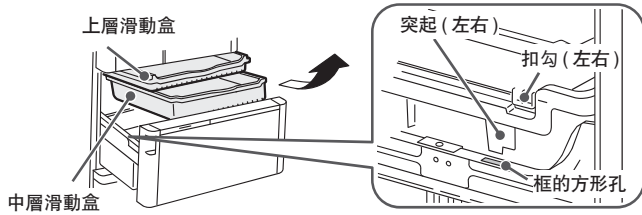

安裝冷凍盒時，請將下層冷凍盒左右突出的部分向門框兩旁的洞插入固定。
請將中層滑動盒兩旁的止動裝置插入下層冷凍盒的外側。

H 上層滑動盒 · 下層置物盒（蔬果保鮮室）

1 將箱門往跟前全部拉出，如圖將上層滑動盒往上拉。

2 手持門的兩端向上抬起，再慢慢的拉出，放在地板上。

3 下層的置物盒朝身體方向向上抬起。

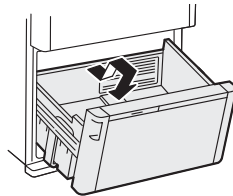
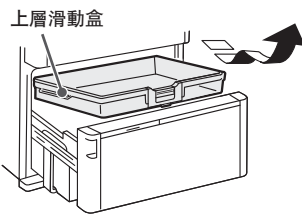

注意事項

● 請勿將門全部拆卸。

注意事項

● 請注意，蓄積的水可能從下層置物盒背面流出。

注意事項

● 不得拆下玻璃隔板。
● 請勿拆卸下層置物盒的潤澤單元及光觸媒。

拉取式門的安裝方法（製冰室·上層冷凍室·下層冷凍室·蔬果保鮮室）

製冰室·上層冷凍室

下層冷凍室·蔬果保鮮室

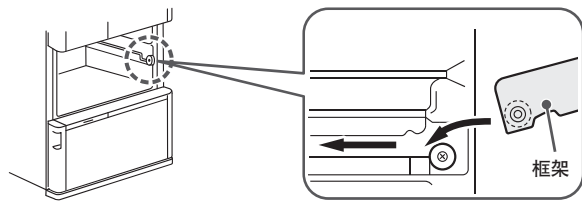
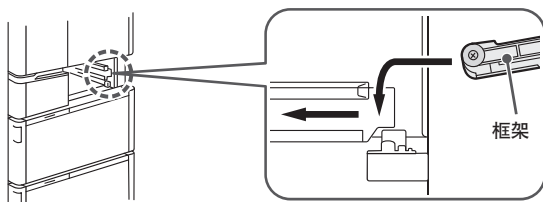

遇到問題時

在委託修理之前，請再次檢查以下幾點。狀況仍然不好的時候，請聯絡所購買的經銷店或敝公司技術中心。

這種情況下		請確認	解決方法
初次使用時	不冷	夏季或食品多的時候，需要時間冷卻。	並不是故障。 安裝之後，可能需要花費 24 小時以上。
	無法製冰	初次使用時，冰箱內冷卻以後才開始製冰運作，所以較費時。 根據食品的量及存放方法，最初的製冰可能需要 24 小時以上。	並不是故障。 請迅速地開閉箱門或盡量少開。 食品之間請空開間隙存放。
操作面板	玻璃觸碰部不起反應	操作部的鎖定設定是否在「開」(鎖定中)的位置？	請解除操作面板鎖定設定。 (→ 25頁)
		冷藏室門開著嗎？	請關閉後再操作。
		操作部分是否附著水滴或是污垢？	請以軟布擦拭。
		戴著手套或貼著膠布嗎？	請直接用手指按。
		是否碰觸到周圍的操作部？	請只碰觸想要操作的操作部。
自動製冰不正常	完全不能製冰	自動製冰機的設定是否設定在「Off」的狀態？	請設定「On」或「Quick」。 (→ 20, 21頁)
		給水告知警示燈是否亮起？	請加水至給水槽內。 (→ 20, 21頁)
		給水槽內的水量減少時，有可能無法製冰。	請試試加水加到給水槽的滿水線。 (→ 20頁)
		給水槽是否推入到超過「水槽裝置」線？	請將給水槽推至比水槽安裝位置更裡面。 (→ 20頁)
		是否將框架往裡面推進，直到發出「卡噠」聲？	請將框架往裡面推進，直到發出「卡噠」聲。 (→ 31頁)
		儲冰盒裡面是否存放了冰外以外的東西？	請從儲冰盒中取出。
	很難結冰 製冰盤裡不給水	儲冰量是否有局部超過最大儲冰界線？	請將冰塊整平。 (→ 21頁)
		是否頻繁地敞開門，是否一次存放了大量的食物呢？ 冰箱內恐怕是沒有充分冷卻。	請試試在冰箱內冷卻前，盡量減少開閉門。請試試盡量空開儲存食品之間的時間。
		冬季每結一次冰可能需要 4 小時以上。	並不是故障。
		從「Off」的設定，變更到「On」的設定之後，結冰的時間會比平常需更長的時間。	並不是故障。
	冰塊有凸起	食品或袋子是否被夾著，冷凍室或製冰室門是否關緊？	被夾住時請除去異物。
		是否設定為「節電」模式 (Save・Trip)？	請解除「節電」模式。 (→ 24頁)
	所儲存的冰塊變小 冰塊之間粘在一起	是製冰盤的溝上積水凍結了。	不是異常。
		長時間積儲著沒使用的舊冰塊，會自然變小，粘在一起。	請將舊的冰塊丟棄，重新製冰。
是否頻繁地敞開門，是否一次存放了大量的食物呢？ 冰箱門或抽屜是否沒完全關緊？		請盡量迅速開閉箱門，以及減少開閉的次數。 關閉冰箱門時，請確實關緊。	
製成的冰塊很小	給水槽的水剩的很少時，會製成的冰塊。	請試試加水加到給水槽的滿水線。 (→ 20頁)	
製成粘在一起的冰塊	框架若沒有安裝在正確位置，可能冰塊會互相粘在一起。	請將框架安裝在正確位置。 (→ 31頁)	
	若製冰盤裡有損傷，冰塊結成時，難以從製冰盤上取下來，會粘在一起。	確認製冰盤是否有刮傷，請向銷售店洽詢，更換製冰盤。	
冰塊裡有白色混濁	是因為混在水中的氣泡被封在冰塊裡面了。	不是異常。	
	用礦泉水製冰了嗎？	水中含有的礦物質凍結會變白而混濁。即使在水裡融化了也會有白色混濁，不過無害。	
製冰盤的框架拉不出來	「Off」的顯示正在閃爍？	當自動製冰機正在製冰時拉不出來。請「Off」的顯示燈亮。 當「Off」顯示閃爍時，請等約一分鐘，等「Off」顯示燈亮後再拉出。 (→ 31頁)	
	食品或袋子是否被夾著，門關緊了嗎？	被夾住時請除去異物。	
不冷 結霜・結露 冰淇淋太軟	是否塞入過多食品，是否一次放入了大量的食物呢？	請遵守可容納食品的高度。 (→ 18, 22頁) 食品之間請空開間隙存放。	
	盒子是否確實地安裝？	請正確安裝好。 (→ 33頁)	
	根據冰箱的設置場所及空隙，環境狀況等，有可能會難以冷卻的情形。	請確認是否已正確安裝。 (→ 10頁)	
	是否設定為「節電」模式 (Save・Trip)？	請解除「節電」模式。 (→ 24頁)	
	溫度設定為「■」時會冷卻不足。	冷卻不足的室內溫度設定請切換為「■■■」或「■■■■」。 (→ 15, 19頁)	
	在夏季等，電冰箱的環境溫度高嗎？	冷卻不足的室內溫度設定請切換為「■■■■」。 (→ 15, 19, 23頁)	
	冰箱門敞開著時，冰箱內的溫度會逐漸上升。頻繁地開閉或是長時間敞開著門的話，冰箱內的溫度會難以下降。	請減少冰箱門的開閉次數及盡量縮短開閉的時間。	

	這種情況下	請確認	解決方法
結霜・結露	冰箱內及・抽屜框架上結霜・結露	冰箱門或抽屜是否沒完全關緊？	關閉抽屜或冰箱門時，請確實確認是否夾到食品或包裝袋，請確實關緊。
		有可能是開關次數多、長時間連續打開了。	請盡量迅速開關箱門，以及減少開關的次數。
		當外部的熱空氣與冰箱內或冰箱門框接觸時，可能會結霜或結露。	此時請以乾布擦拭。
		當開關冰箱門時，空氣中所含的水份，會凝結成霜或冰，可能會附著在冷凍室的壁面及零件上。	並不是故障。 此時請以乾布擦拭。
結霜・結露	冰箱的外側結露 (箱體、門的密封墊、門、抽屜等)	下雨天等室內濕度高的時候會結露。	並不是故障。 此時請以乾布擦拭。
		將防止結露的加熱器調弱時，濕度較高時隔板的鐵板部份、冰箱門密封墊、冰箱門可能會有結露的情形。	請解除防止結露的加熱器設定。 此時請以乾布擦拭。 (→ 26頁)
		溫度設定在「■■■■」時，冰箱門表面可能會有結露的情形。	此時請以乾布擦拭。 把溫度設定調至「■■■」的階段。
結霜・結露	冷藏室中凝結露水	冰箱門的開關次數頻繁時，或冰箱周圍溫度高時，壁面會起霧，在冷氣出風口附近會凝結露水。 	並不是故障。 此時請以乾布擦拭。
		凝結露水	
結霜・結露	蔬果保鮮室中凝結露水	蔬果保鮮室特別是蔬果睡眠保鮮空間，比其他的冷藏室的濕度還要高。這是為了避免讓蔬菜乾燥以長久保存，並非異常現象。	若擔心結露，請將食品以保鮮膜包裹後存放。
		凝結露水過多時，水可能積在蔬果保鮮室的盒子等中。	水蓄積時很容易造成食品的損壞，請用乾布擦拭乾淨。
		可能因食品的包裝袋或容器阻塞潤澤單元，而導致蔬果睡眠保鮮空間內發生結露的現象。	請將阻塞在潤澤單元部分的食物包裝袋及容器移到其他位置。
大冷	太冷凍結了	溫度調節為「■■■■」了嗎？	請設定為「■■■」。 (→ 15, 19頁)
		環境溫度是否 5°C 以下呢？	周圍溫度低時可能冰箱內的溫度會太冷。請將溫度調節為「■」。
		是否放置在冷氣吹出口的前方？	請不要放在冷氣吹出口的前面。
箱門高低不平衡以及歪斜	左右箱門高低不平衡箱門歪斜	有可能設置的地方沒有水平。	性能上沒有問題，可以照舊使用，不過介意的話，試試調整左右的調整腳。 (→ 10頁)
		是否由於地板材質太軟加上儲放物的重量使冰箱腳下沉？	冰箱本體傾斜的時候，請鋪上 1cm 以上厚的堅固的板子。
	關上門之後再立刻打開時感到吃力	是因為進入了冰箱內的空氣忽然受到冷卻，氣壓一時變低。	不是異常。
	關門時其他的門會開	因為各室的冷氣通路是相通的，關門時由於風壓使其他門會一瞬間打開。	不是異常。
聲音不對	冰箱發出的聲音嘈雜	地板是否有彎曲？	請鋪上堅固的板子後，再將冰箱安裝在板子上。 (→ 10頁)
		冰箱是否靠著牆或家具？	請在冰箱的周圍空出間隙安裝。
		遮蔽架是否脫落了？	請正確安裝好遮蔽架。 (→ 10頁)
		購買後，剛開始使用等冰箱還未冷卻時・箱門開閉頻繁時，周圍的溫度高時，由於壓縮機高速運作，可能會感覺到聲音大。	充分冷卻後，聲音會變小。
		設定在「Freezer」「Fridge」「Quick」時，壓縮機及風扇馬達會加速運轉，聲音會變大。	不是異常。
	運作音長	是為了讓壓縮機慢慢地運轉，是在省電運作。	不是異常。
		有時聲音變大	是因為運轉力隨著冰箱內的溫度變化在變更。
	其他 例如聽到這樣的聲音時	像流水的聲音 (啾啾啾)	是電冰箱的冷媒流動聲，融霜時的水流聲蒸發聲。 不是異常。
		像碰撞的聲音 (叩叩叩)	
		像沸騰的聲音 (啾啾啾)	
像燒肉的聲音 (唧~)			
像摩擦的聲音 (啾啾) (“叩動”聲)		是冰箱的溫度變化時，或真空開 +1°C 室的氣壓變化時，部件的摩擦聲。 不是異常。	
像什麼被卡著的聲音 (啾啾啾)		是控制冰箱內溫度的電氣部件或真空幫浦的運作聲。 不是異常。	
聲音不對	其他 例如聽到這樣的聲音時	像呻吟的聲音 (嘖~)	
		像剛關門時的聲音 (吓~)	
		自動製冰機的聲音 (啾~)	是冰塊從自動製冰機的製冰盤掉落時，或是製冰盤裡給水時所發出的聲音。給水槽空的時候，每隔 2 至 3 小時也會發出聲音。按下  按鍵，讓其顯示為「Off」時，就不會發出聲音。 (→ 21頁)
		時常有的聲音 (卡嗒卡嗒)	為了冷卻冰箱內開始運作時的聲音。 不是異常。
冰箱發熱	電冰箱的側面發熱箱腳底下吹出暖風	為了讓冷卻裝置運作時所發出的熱氣向外排而會發熱。	剛安裝後或是夏季，可能會有 50 ~ 60°C，在安全上及性能上沒有問題，但請勿以手觸摸。

遇到問題時 (續前頁)

這種情況下		請確認	解決方法
有異味	有塑膠味	是因為在冰箱內使用了多數的塑膠部件，不過，充分冷卻後自然就會慢慢減輕。	不是異常。
	冰塊有異味	給水槽・淨水濾片骯髒嗎？冰塊舊嗎？ 由於自來水中的氯元素凝縮，氯的氣味會很重。	為了防止「發黏」「水垢」，請定期清洗。 (→ 31頁)
	冰箱內有異味	是否直接地儲放了氣味重的食品呢？	脫臭機能不能完全去除所有的氣味。 請用保鮮膜等密封後儲放。
真空冰溫室的問題	打開時，不發出「咻-」的聲音	真空冰溫室的設定是否為「全滅燈」(非真空的冰溫)？	請將設定改為「-1°C」或「+1°C」 (→ 17頁)
		把手往上翹著嗎？	請將把手往下押，鎖定。
		把手是否有推到最終的位置，牢牢地鎖住？	如果沒有鎖住，則無法啟動真空機能。 請上鎖。
		真空冰溫密封墊是否脫離？	請安裝真空冰溫密封墊。
		真空冰溫密封墊與承受部之間是否夾著食品的包裝袋、頭髮等？	若食品包裝等異物被夾住時，請除去異物。 請清洗髒污的真空冰溫密封墊。 (→ 29頁)
	不知道是否在真空	是否在真空冰溫室或冷藏室門開啟關閉之後？	真空幫浦是在開始運作的準備狀態下，可能不發出「咻-」的聲音，並不是故障。
		打開時如有「咻-」的聲音，便是正常。	-
	把手不能上鎖	真空冰溫密封墊部分及真空冰溫盒的裡面是否有食品等被夾著呢？	若有被夾住請除去異物。
		是否正確地安裝真空冰溫盒？	請依照要領正確的安裝真空冰溫盒。 (→ 32頁)
	真空冰溫室的周圍發出「哐~」的聲音和振動	是真空幫浦的運作聲音。	不是異常。
如夜間等介意有聲音的時候，可以停止真空幫浦的運作。		請變更真空冰溫室的設定，讓其顯示全滅燈。 (→ 17頁) (變為非真空的冰溫)	
當聲音及震動頻繁時，有可能真空冰溫盒夾到異物，或是真空冰溫密封墊有污垢。		若食品包裝等異物被夾住時，請除去異物。 請清洗髒污的真空冰溫密封墊。 (→ 29頁)	
真空冰溫室的內部或真空冰溫盒的周邊有水滴或結霜	因為真空冰溫室是密封的狀態，如果存放水分較多的食品時，水分蒸發會在室內凝結成露水或結成霜。 	水分較多的食品建議以保鮮膜包覆。如果附著了水滴或結霜，請以乾布擦拭。	
存放的蔬菜表面呈凹陷，變色	是否存放了茄子、黃瓜等不耐低溫的蔬菜呢？	請移動至蔬果保鮮室。 (→ 17頁)	
真空冰溫室的食品凍結	設定是否為「-1°C」或是「全滅燈(非真空的冰溫)」的狀態？	請設定為「+1°C」 (→ 17頁)	
操作部的顯示等呈閃爍的狀態	 閃爍	告知有異常。	請與購買的經銷店商洽。
	 閃爍	有可能食品等碰到製冰盤。	請先將製冰室內清空，再操作「製冰機清潔」。 (→ 30頁)
	 閃爍	有可能是設定在工作人員確認運轉用的模式。(※1)	約 15 分鐘後恢復通常模式。 使用上沒有問題。
	  閃爍	有可能是設定在工作人員確認運轉用的模式。(※1)	約 10 分鐘後恢復通常模式。 使用上沒有問題。
	   全部呈閃爍	正在進行「製冰機清潔」。	請確認「製冰機清潔」 (→ 30頁)
	 閃爍	在製冰中途按下「Off」時會閃爍。	請確認清潔中的「製冰盤」。 (→ 31頁)
	全部的顯示閃爍。	箱門敞開了 1 分鐘以上的狀態。(門沒關緊等)	請確認「箱門警示聲」 (→ 25頁)
	以上各項以外的顯示燈閃爍	有可能是服務人員的動作確認模式。(※1)	請與購買的經銷店商洽。

※1 長時間 (10 秒鐘以上) 碰觸同一個鍵鈕時，可能會成為確認運轉用的式樣。

	這種情況下	請確認	解決方法
電動冷藏室門	聲響很大。 有些不正常的聲響。	碰撞的聲音（嘖嘖・嘖嘖）	這是電動冷藏室門的操作聲響。 不是異常。
		低沉的聲音（吭吭）	這是電動冷藏開門器的操作聲響。 不是異常。
		電動冷藏室門的操作聲音左右各不相同。	隨著冰箱的設置條件，冷藏室門層架的收納食品多寡有所不同。 不是異常。
	雖碰觸電動冷藏室門的操作部，也打不開。	Auto Door 顯示燈是否熄滅了？ 製冰室或上層冷凍室的任何一個是否開啟狀態？	請讓 Auto Door 顯示燈亮。 → 12頁 請關閉開啟的抽屜門後，再碰觸電動冷藏門的操作部。
	電動冷藏室門不能關閉。	是否有食品或食品袋卡在抽屜內？ 電動操作時是否停電或者箱門受到了撞擊？	請除去被夾住的食物等異物。 因為電動冷藏室門的功能在中途停止，請以手動方式關上冷藏室門。
	電動冷藏室門的開啟程度較小。	收納的飲料或食品是否觸及冷藏室內壁？ 有可能擺放場所不是水平的狀態。	請除去觸及內壁的飲料或食品。 隨著冰箱的設置條件，電動冷藏室門開啟的角度可能有所改變，或在開啟之後會稍微關閉的情形，這並非故障。
縱使操作面板鎖定時電動冷藏室門仍可以動作。	即使操作面板鎖定時電動冷藏室門的功能也不會停止。	若想讓電動冷藏室門功能停止時，請先解除操作面板的鎖定，再按下 Freeze 按鍵持續 3 秒直到發出嗶嗶聲響為止。 → 12, 25頁	
電動抽屜	聲響很大。 有些不正常的聲響。	碰撞的聲音（嘖嘖・嘖嘖）	這是電動抽屜的操作聲響。 不是異常。
		呻吟的聲音（嘆～）	這是電動抽屜的操作聲響。 不是異常。
		蔬果保鮮室比冷凍室下層的運轉聲音大。	“蔬果保鮮室”的操作聲響比“下層冷凍室”的大。 不是異常。
	即使按下電動抽屜開關，箱門也不開啟。	Auto Drawer 顯示燈是否熄滅了？ “下層冷凍室”或“蔬果保鮮室”是否開著？	請讓 Auto Drawer 顯示燈亮。 → 13頁 關上開著的電動抽屜，再按下你要打開的電動抽屜開關。
	電動抽屜不能開啟 / 關閉。	是否有食品或食品袋、保鮮膜等被夾住？ 電動操作時是否停電或者箱門受到了撞擊？	請除去被夾住的食物等異物。 箱門不能開關自如，因為沒有正常完成電動抽屜功能操作。用力的將箱門推入。或者請在拉開門的狀態下拔掉電源插頭，等 10 秒左右後再插上。
	電動抽屜開啟得不夠大。	開始動作時，推出抽屜的尺寸大約在 15cm 以上。	隨著冰箱的設置條件，有可能拉出抽屜的尺寸稍微不同，或是門以電動的方式開啟後又稍微退回的現象。 不是異常。
縱使操作面板鎖定時電動抽屜仍可以動作。	即使操作面板鎖定時電動抽屜的功能也不會停止。	若想讓電動抽屜功能停止時，請先解除操作面板的鎖定，再按下 Freeze 按鍵持續 3 秒直到發出嗶嗶聲響為止。 → 13, 25頁	
其他	觸碰到機體會感覺到微量的電流	——	電冰箱會帶有靜電，安全上沒有問題。
	電視機・收音機等發生有雜音・映像的花亂	是從電冰箱發出的微弱電磁波的影響。	要安裝時請遠離電視機、收音機、門鈴對講機等。建議在離開天線等的地方接電源。 → 11頁
	塑膠零件上有像傷痕一樣的細線	是塑膠成型時發生的樹脂流痕。	透明的部件會特別顯眼，強度上沒有問題，不會破裂。
	箱門面或側面・頂面上有波紋或歪扭	冰箱的製造工程上，會發生輕微的波紋或歪扭。	根據照射方向及亮度等會感到顯眼，這不是異常現象，在性能上也沒有問題。
	操作部顯示滅燈	完成操作之後，為了省電約 40 秒後滅燈。	不是異常。 但「節電」模式的設定及「Fridge」「Freezer」「Quick」運轉時的顯示、及「Off」「Water」的通知顯示、環保運轉的「eco 運轉顯示」則不會滅燈。 讓其燈亮，請打開冰箱門，或按下 MENU 按鈕。
	箱門內側有小的洞	這個洞是在冰箱製造過程中，填充斷熱材料時為了讓內部的空氣往外散所挖的洞。 	不是損傷也不是異常情形。
	停電了	在到恢復之間，請減少箱門的開閉，避免重新再存放食品。	停電後恢復供電時，請確認操作部位的設定。
	長時間不使用冰箱	請將冰箱內的東西全部清出。	所有的門打開讓其乾燥 2～3 天。 → 28～31頁
	不製冰時	請設定程「Off」。	請參考「製冰停止」的說明。 → 21頁
	除霜	此電冰箱自動除霜，不需要操作。	溶解了的水會積在蒸發盤上，自動蒸發。
	移動・搬運		請參閱「移動・搬運的事前準備（搬家時）」 → 11頁

遇到問題時 (續前頁)

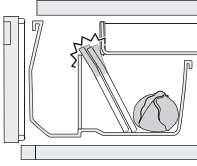
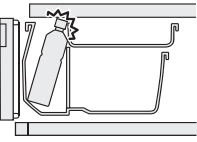
這種情況下		請確認	解決方法
其他	蔬果保鮮室的門無法關閉・蔬果保鮮室的門開啟時上層滑動盒無法回復到鎖定的位置	上層滑動盒與下層置物盒之間是否夾有食品等異物？ 	請除去被夾住的異物。
		上層滑動盒的鎖定把手是否碰到寶特瓶或食品？ 	存放寶特瓶或食品時請注意避免碰觸到鎖定把手。
	玻璃破裂 (冰箱門玻璃 玻璃層架 玻璃隔板)	_____	請勿觸碰破碎的玻璃，立刻聯絡購買的銷售店，委託修理。
	小蒼蠅等昆蟲飛入冰箱時	周圍是否有蒼蠅？ 冰箱內是否存放氣味強烈的食品？ 箱門是否長時間開啟？	敬請保持周邊環境乾淨。 請放置蒼蠅忌避物品或補蠅器。 為了避免氣味吸引蒼蠅，請將食品加蓋或以保鮮膜包覆。 請盡量在拿取食品後馬上關上箱門。

另購零件

■以下零件更換時，請務必向經銷店指明冰箱的型號，購買專用的零件。

這種情況時	商品名	商品型號	
冰塊有味道時 ●可能淨水濾片老舊・髒污。 (約3~4年更換一次)	自動製冰用淨水濾片	RJK-30	
無法維持真空狀態 ●可能破損・變形・變色	真空冰溫密封墊	R-C6700 321	

CONTENTS

BEFORE USE

SAFETY SUGGESTIONS	40
LEARN NAME & FUNCTION OF EACH PART ...	44
Name of each compartment/Food stored	44
Accessories	44
Functions of the Open Button	45
BEFORE USE	46
Preparation before use	46
Transporting your refrigerator (transport for moving) ...	47

GENERAL USE

Auto Door	48
Setting the Auto Door	48
Using the Auto Door	48
Auto Drawer	49
Set the Auto Drawer	49
Using the Auto Drawer	49
REFRIGERATOR COMPARTMENT	50
Adjust the height of a pocket/shelf	50
Using a multiuse egg case	51
Adjusting temperature in a refrigerator compartment ...	51
Cooling food Quickly (Quick Cooling)	51
VACUUM COMPARTMENT	52
When opening/closing the door of the Vacuum Case ...	52
Change the settings of the Vacuum Compartment ...	53
FREEZER COMPARTMENT	54
Using the Upper Freezer	54
Using the Lower Freezer	54
Caution on how to store foods	54
Adjust the temperature of the freezer compartment ...	55
Quickly freezing foods (Quick Freezing)	55
ICE COMPARTMENT (AUTOMATIC ICE MAKER) ...	56
How to make Ice	56
Quick Ice Making	57
Stop Ice Making	57
When the "On" indicator lamp is blinks	57
Water Supply indicator	57
Stored ice amount and ice-making time of the Ice Case ...	57
VEGETABLE COMPARTMENT	58
Stored foods	58
Caution on how to store foods	58
Using the Aero-care Zone	59
To cool it more [Vegetable Compartment (MAX)]	59
VARIOUS FUNCTIONS	60
Setting "Energy Saving" mode	60
"eco" Operation indicator lamp	60
Locking the Open Button	61
Door Alarm	61
Door Alarm and volume adjustment of the operation sound ...	61
Set the condensation prevention heater to MIN.	62
Fine adjustment of the temperature (Refrigerator Compartment / Freezer Compartment)	63

MAINTENANCE

MAINTENANCE (REGULAR CHECK)	64
Power plug/The back/floor of the refrigerator/Surface of door ...	64
Each shelf/pocket/case/Door gaskets/Liquid receivers ...	64
Vacuum Compartment/Auto Drawer	65
Ice Maker Cleaning	66
Water supply container/Ice tray	67
HOW TO REMOVE/ATTACH PARTS	68
Height adjustable upper and middle shelf (Glass shelf) ...	68
Door pocket	68
Fixed shelf	68
Height adjustable lower shelf	68
Vacuum Case	68
Ice Case (Ice Compartment) • Upper Freezer case (Upper Freezer) ...	69
Slide case and lower freezer case (Lower Freezer)	69
Upper Case, Lower Case (Vegetable Compartment)	69
How to attach the slide door (Ice Compartment/Upper Freezer/Lower Freezer/Vegetable Compartment)	69

TROUBLESHOOTING

TROUBLESHOOTING	70
Initial stage	70
Open Button	70
Automatic ice making is not properly performed ...	70
Refrigerator does not cool	70
Frost and/or dew occur	71
Refrigerator cools overly	71
Door is not in a horizontal state	71
Abnormal operating sound is generated	71
Refrigerator becomes hot	71
It smells strange	72
There is something strange with the Vacuum Compartment ...	72
[] display on the Open Button flashes	72
Auto Door	73
Auto Drawer	73
Others	73
AVAILABLE PARTS	74
ABOUT NON-CFC REFRIGERATORS/ STORABLE WEIGHT	75

遇到問題時 (續前頁) / 另購零件

SAFETY SUGGESTIONS

Ensure to follow these precautions

When using this appliance, failure to follow safety precautions may result in personal harm, harm to other people, and also damage to property.

■ The following pictographs categorize and explain the level of possible harm or damage that may occur from ignoring suggestions resulting in missing the appliances.

	WARNING	Suggestions headed by this pictograph indicate "There is high chance of serious injury or death" if ignored.
	CAUTION	Suggestions headed by this pictograph indicate "There is a high chance of injury or damage to property" if ignored.

■ How the suggestions should be taken are indicated and categorized by the following symbols accompanied by explanations. (The symbols below are examples)

	This symbol indicates something you must not do. (Prohibited)
	This symbol indicates something you must do. (Compulsory)

■ This refrigerator uses flammable refrigerants. The symbol column below states the precautions on flammable refrigerants.

This symbol denotes the precautions on flammable refrigerants.
R600a

WARNING

Installation

- Take measures to prevent overturning of refrigerator due to earthquake, etc.**
 - Overturning of the refrigerator could result in personal injury.
- Do not install the refrigerator in damp places or where water may splash.**
 - This may impair electricity insulation causing electric shock or fire.

Handling the power and power cable

- Avoid usage that may cause the wall outlet or power cord components to work beyond the specified voltage. Also do not use power sources that are not a rated voltage current.**
 - If a power source is shared with other appliances, double or multipoint adapters may heat up beyond normal levels and cause fire.
 - Use a wall outlet rated above 10 ampere by itself.
- Connect the power plug firmly to a power outlet with the cord running down.**
 - Connection of the power plug with the cord running up could apply stress on the cord and cause electrical short or overheat, which could result in electrical shock or fire.
 - Incomplete connection of the power plug could result in electrical shock or fire due to heat.
- Do not do anything that may damage the power cord or plug.**
 - The power cord or plug should not be cut, modified, touched with hot implements, bent by force, twisted, pulled, have heavy objects placed on it, squeezed by the refrigerator, or be bound or tied up.
- Do not insert or remove the power plug with wet hands.**
 - This may result in electric shock.
- This appliance is not intended for use by persons (including children) with reduced physical, sensory or mental capabilities, or lack of experience and knowledge, unless they have been given supervision or instruction concerning use of the appliance by a person responsible for their safety. Children should be supervised to ensure that they do not play with the appliance.**

⚠ WARNING

Handling the power and power cable



- **Clean the dust on the power plug frequently.**
Insulation failure from moisture when dust collects on the power plug may cause fire.



- **Be sure to unplug the power plug before maintaining the refrigerator.**

Continued use may cause electric shock or injury. Pg.64

- Always hold the plug when unplugging it.

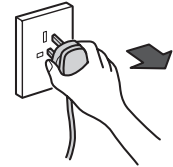

During use



Wetting Prohibited

- **Do not splash water on or inside the refrigerator.**

- This may impair electrical insulation causing electric shock or fire.



Prohibited

- **Do not put in things that may catch fire.**

- Benzine, ether, LP gas, thinner, adhesives may ignite an explosion.

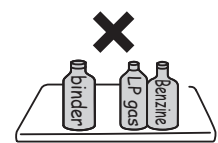

Wetting Prohibited

- **Do not put water containers on the refrigerator.**

- Spilled water may impair insulation of electrical components causing faulty electrical currents. This may result in electric shock or fire.



Prohibited

- **Do not use flammable sprays near the refrigerator.**

- Sparks from points of electrical contact such as door switches may ignite a fire.

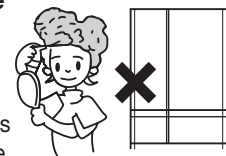

Prohibited

- **Do not put things on top of the refrigerator.**

- Opening and closing doors etc. may cause things placed on top of the refrigerator to fall resulting in injury.



Prohibited

- **Drugs, chemicals, research and experimental substances should not be stored in the refrigerator.**

- Substances that require precise conditions for storage cannot be stored in a domestic refrigerator.



Contact Prohibited

- **Do not touch the machinery components of the automatic ice maker.**

- There is a danger of injury when the ice trays are rotating.



Prohibited

- **Do not hang on the doors or step on the various compartments.**

- Injury may be caused by the refrigerator tipping over or hands getting caught between doors.



- **Children should be supervised to ensure that they do not play with the appliance.**



Prohibited

- **Do not remove the cover of the interior lamp.**

- When the interior lamp is damaged, please contact the service centre for replacing the lamp to avoid injury.

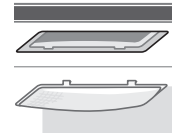

Prohibited

- **Do not put too much force on the door by opening it too much or leaning on the opened door.**



Prohibited

- **Do not add impact to the glass door.**

⚠ WARNING R600a

Concerning the refrigerant (Be careful of the following related to the use of flammable gas R600a: ISOBUTANE.)



Prohibited

- Do not scratch or damage the main body of the refrigerator with a sharp object such as a screw.

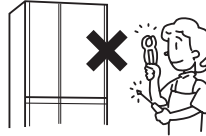

Since the refrigerant used is flammable, any leakage from the pipe inside the wall may cause ignition and explosion.



- Allow clearance around the refrigerator and keep ventilation openings when installing it.

 Pg.46

Leakage of the refrigerant may accumulate and cause ignition and explosion.

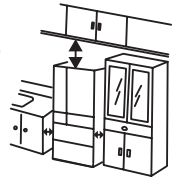

- Do not damage the refrigerant circuit. If you happen to damage the refrigerant pipe, stay away from the refrigerator and avoid using fire and electrical appliances.

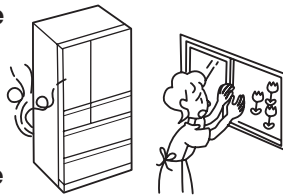

Should you damage the refrigerator, open the window to ventilate and contact the authorised service centre.



- Please consult your dealer or the Recycle Hotline of the Recycle Centers in the Environmental Protection Administration when discarding the unit.

If the refrigerant is wet, it may cause ignition and explosion.



Prohibited

- Do not use mechanical devices or other means to accelerate the defrosting process, other than those recommended by the manufacturer.

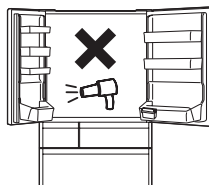

Prohibited

- Do not use electrical appliances inside the refrigerator.

• If the refrigerant leaks, sparks on the contact may cause ignition and explosion.

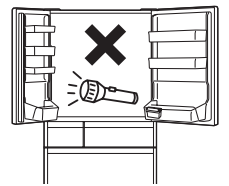

R600a

- The warning label and name plate including this symbol affixed on compressor and refrigerator should be kept throughout the life of the refrigerator.

In case of emergency



- Stop the refrigerator by unplugging it if it is not running properly or breaks down.

Continue may cause electric shock or injury.
• Always hold the plug when unplugging it.

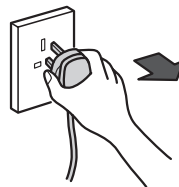

Disassembly prohibited

- Do not disassemble, repair, or modify your refrigerator.

Injury may be caused by ignition of fire or faulty running.

• Please consult with a retailer if any repairs or disassembly are required.



- In the event of gas leak, do not touch the refrigerator and open windows to allow ventilation.

• Sparks from points of electrical contact such as door switches may ignite explosions causing fire or burn injuries.



When discarding the unit



- Before discarding the unit or recycling, remove the door packing to avoid the risk of an infant or child to be entrapped inside.



CAUTION

When moving the refrigerator



Prohibited

- **Do not move the refrigerator by using its wheels as it may damage the floor.**

- Please lay a protective mat.

- **Never hang the handle with a crane, etc.**

- **Take care not to bang the back / side of the refrigerator.**

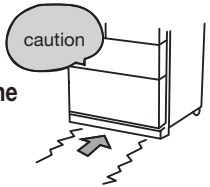

- **Use the carrying handle when carrying it.**

Your hands may slip resulting in injury if you hold the refrigerator at other places than the carry handles.

- More than 2 persons should carry the refrigerator for safety reasons.
- Carry it with the door facing upward; as shown in the illustration.
- Never hang the handle with a crane.
- Use a tape to fix an electric plug/power cord so that it may not hang down.

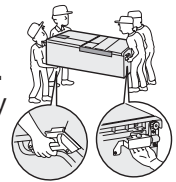

During use



Prohibited

- **Do not put bottles in the Door Baskets if they do not sit properly on the bottom of the front section.**

- Forcing in items like large bottles may result in them getting tipped over, causing injury.



Prohibited

- **Do not have food items protruding over the front of the shelves.**

- Injury may be caused from items like bottles getting knocked over.

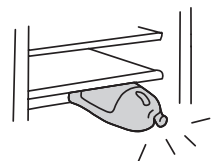

Prohibited

- **Do not put the glass bottles in the Freezer Compartment.**

- Bottles may break from the contents freezing and cause injury.

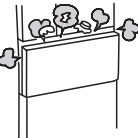

- **When two or more doors are being opened or another person is using the refrigerator, make sure fingers do not get caught.**

- Fingers may get caught in the spaces between doors causing injury.



Prohibited

- **Do not hold the top of the doors when closing them.**

- If you hold the top of a door when closing it you may get your fingers caught or pinched and cause injury.

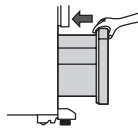

Prohibited

- **Do not touch the food and containers inside the Freezer Compartment with wet hands.**

- This may cause frost injury. (Especially in the case of metal items)



Prohibited

- **Do not put your feet too close when opening the bottom door of the refrigerator.**

- When opening this door you may hit the instep or other parts of your feet resulting in injury.



Prohibited

- **Do not eat food that smells strange or has changed color.**

- Spoiled food may cause serious sickness.



Prohibited

- **Do not put your hands or feet under the base surface of the refrigerator.**

- When cleaning, putting your hands under the base surface of the refrigerator may result in injury by cutting them on sheet metal parts.

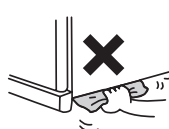

Prohibited

- **Do not press the auto door switch on the Auto Door with knee, etc.**

- **Avoid placing anything like a bottle near the auto door compartment.**



Prohibited

- **Do not give a hard impact to the glass shelf/partition. (The glass shelf/partition may be broken, causing personal injury).**

- **Be careful not to operate the Auto Door when another person is in front of the refrigerator, which may lead to personal injury unexpectedly caused by the opening door.**



Prohibited

- **Neither heat the glass surface of the glass shelf/partition nor put a hot item on it.**

- **Do not stack up food in the Multiuse Egg Case. Keep food in order within the shelf. Put juicy food in a sealed container.**



Prohibited

- **Take care to remove the glass shelf because it is heavy.**



LEARN NAME & FUNCTION OF EACH PART

Name of each compartment/Food stored

Refrigerator compartment → Pg.50
About 2°C ~ 6°C

Refrigerating food

The temperature at the door pocket is slightly high.

Vacuum compartment → Pg.52
About -1°C ~ 1°C

Fresh foods such as meat, fish and seafood
Vacuum and photo-catalyst help to keep foods fresh.

Ice compartment
→ Pg.56
About -20°C ~ -18°C

The ice cubes made by the automatic ice maker.

Vegetable compartment
→ Pg.58
About 3°C ~ 7°C

Vegetable, fruits, drink

Upper space
Unfinished vegetables, small vegetables, fruits, etc.

Tall Storage Compartment
Tall vegetables, 2L PET bottle, etc.

The temperature of the Tall Storage Compartment is a little higher.

Aero-care zone
Leaf vegetables (spinach, Japanese Mustard Spinach etc.), large vegetables (cabbage, lettuce), etc.

※ The above temperatures are standard values under the condition that the refrigerator is stable with no food stored and the door closed, at ambient temperatures of 30°C.

- Store foods in a loosely arranged way.
- It is recommended to wrap smelling foods.

Accessories

Warranty certificate	Please show it for repair.
Specialized tool (with 2 cushions)	Please use it to fix the refrigerator. → Pg.46

Functions of the Open Button

The Open Button is a touch panel made of glass.

If you touch **MENU** button, the current settings will be displayed.

The upper portion of the Open Button is the display and the lower portion is for operation.

Touch the lower portion of the Open Button to change the settings, if necessary.

Caution

- Please close the door of the refrigerator door before changing the settings.

Providing information

eco It will turn on while it is working in "eco" mode. → Pg.60

Key It will turn on while the Open Button is locked. → Pg.61
Blink indicating any trouble. → Pg.72

Auto Door It is lit when the Auto Door is set to "ON". → Pg.48
* Only for R-E6800X type

Auto Drawer It is lit when the Auto Drawer is set to "ON". → Pg.49

Water It will turn on when water in the water supply container is getting low. → Pg.57

※All the indicator lamps are lit for the sake of explanation.

eco Auto Door

Key Auto Drawer

Water

■■■ ■■■ Quick Fridge

■■ Trip On Freezer -1°C

■ Save ■ Off Veg +1°C

MENU

Energy Saving

Button Lock (Press 3 Sec.)

Freezer

Auto Drawer (Press 3 Sec.)

Fridge

Auto Door (Press 3 Sec.)

Ice Maker

Cleaning (Press 5 Sec.)

Powerful

Vacuum

First touch it.

Setting Energy Saving mode

Set Energy Saving mode. Energy-saving by reducing cooling power of each compartment.

"Trip" → Pg.60

"Save" → Pg.60

Adjusting temperature settings

Set temperature for each compartment. Normally, use the "■■■" setting.

Refrigerator Compartment → Pg.51

Freezer Compartment → Pg.55

Setting an ice-making

Set the ice making mode

"Quick" → Pg.57

"On" → Pg.56

"Off" → Pg.57

Setting a cooling mode

Set a cooling mode

"Fridge" → Pg.51

"Freezer" → Pg.55

"Veg" → Pg.59

Setting the Vacuum Compartment

Set the Vacuum Compartment mode.

-1°C → Pg.53

+1°C → Pg.53

All lamps off → Pg.53

Display area For operation

Notice

About the display

- Close all the doors before adjusting the settings. While a door of the refrigerator is opened or an indicator lamp on the display is blinking, it will not work even if you touch the Open Button.
- If you confirm the setting, touch **MENU** button or open the refrigerator door. The display will be lit again.
- If you touch **MENU** button again after finishing the operation, it will be unlit. The displayed characters will be unlit 40 seconds later without touching the **MENU** button again for energy-saving. However, the setting of "Energy Saving" mode, "Fridge", "Freezer" and "Quick" indicator lamps and "Off" and "Water" indicators and ["eco" operation indicator lamp] will not be unlit.
- When opening the refrigerator door and the displayed characters are lit, they become unlit about 15 seconds after closing it.

About the Open Button

- Response of the touch panel may change depending on the surrounding temperature, humidity, physical condition of the user or operation status of the adjoining electric product.
- Release a finger and touch the panel again if the panel does not respond after touching it. False detection may occur (it may be kept pressed) if the time interval between key touches is too short. Response of the touch panel does not improve even if you touch it strongly.
- The panel may not respond if it is wet or dirty. Wipe it off with a dry cloth.

BEFORE USE

Preparation before use

1

Please arrange it as shown below

- The floor should be sturdy and flat.
Lay a board with 1cm thickness on the floor if the refrigerator is installed on the carpet, tatami mat, flooring or PVC sheet flooring which may be hollow or discolor.
- Place the refrigerator away from direct sunlight and heat.
- Do not place it in damp areas, and ensure good air ventilation.
This will reduce adverse effects to refrigerating power and keep electricity cost down. This will also prevent the refrigerator from discoloring and rusting.
- The place is separated from other equipment.
To prevent disturbance (noise / scattered image) to TV and others attributable to the refrigerator.
- To cool efficiently, allow enough space around the refrigerator for radiating heat.
- The actual size of the center part of the side of the refrigerator's main body is slightly larger than the nominal size. Therefore, please allow enough space around when installing the refrigerator.
- The back of the refrigerator can be placed very close to the wall. If any vibration sound occurs and/or any discolor/dirt is found on the wall, move the refrigerator away from the wall.

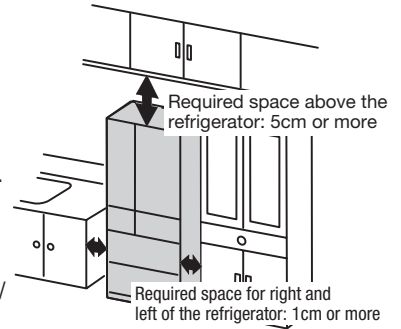

2

Fix the refrigerator

The adjustable mounts, which are located in the front bottom corners of the refrigerator, can be adjusted by turning them to level the refrigerator. (Make sure to use a supplied tool and 2 cushions)

- 1 To remove leg cover, hold both ends of it and pull it towards to you by applying some force.**

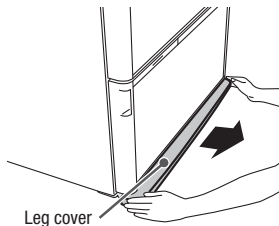

- 2 Place pads under the adjustable mounts.**
Place pads under the adjustable mounts evenly so that they can be leveled.

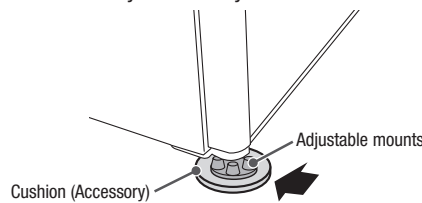

- 3 Lower both adjustable mounts (left and right) by turning them to secure the refrigerator.**
Clamp the supplied tool adjusting to the shape of the adjustable mounts.

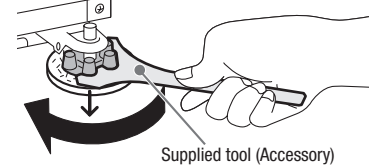

- Always wipe the adjustable mounts and floor clean before placing pads. Adherents may scratch the floor if they remain.
- Be careful not to scratch the floor with the supplied tool when turning the adjustable mount.

3

Adjusting the refrigerator adjustable mount to keep it level

- Left side or right side door may be slightly lower when the surface of the installation place is not level or either left or right leg sinks in the floor surface because of the soft floor material and the addition of food weight.

→ This does not affect the refrigerator function. Adjust the refrigerator adjustable mount to keep it level according to the procedure listed below if you want to correct it.

Correcting any left/right lean and lifting slightly the front side of the refrigerator until the door can close easily and completely.

- 1 With the supplied tool, turn an adjustable mount on the side so that the refrigerator is lower to make the Refrigerator Compartment door level.**

The height of the door can be adjusted 1mm every one turn of the adjustable mount.

- The left side of the door is lower.

- The right side of the door is lower.

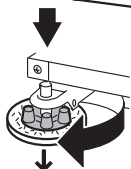
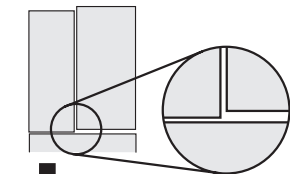

Turn the left Adjustable mount to lower the left side door.

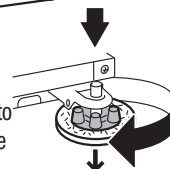
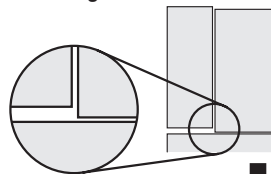

Turn the right Adjustable mount to lower the right side door.

- 2 Insert the left and right pins of the leg cover into the mounting holes to attach the leg cover.**

It may be approx. 5 days before the refrigerator conforms to the floor allowing the door to be leveled. Readjustment is required if the door is not leveled.

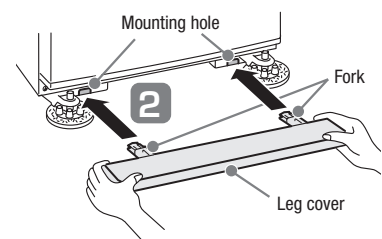

Notice

- When you release your hand from the refrigerator door with the door open, the door may move, but this is normal.

4

Peel off the seal from the Antioxidation Fresh Cassette in the Vacuum Compartment.

Peel off the seal from the Antioxidation Fresh Cassette set in front of the Vacuum Compartment before use.

- Antioxidant constituent and hot flavor will not be released until the seal is peeled off.

Caution

- Do not wash it in water.
- Do not smell it directly. It may be irritating to the nose.

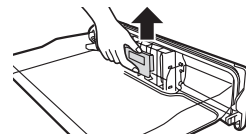

Pull it out right above.

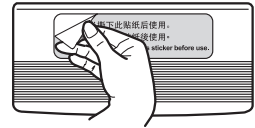

Peel off the seal, and then return it back.

5

Plug the power cord.

It is not a problem to plug in the power cord soon after installing the refrigerator.

Use a wall outlet exclusively when connecting the power cord. (Alternating current 220 - 240V, rated 10A or more)

- Check that the power plug or the cord is not wedged between the back of the refrigerator and the wall in order to prevent the cord from getting hot.

Cooling inside the refrigerator starts.

- It may take more than 4 hours to cool well the inside of the refrigerator, depending on conditions such as the ambient temperature or storage state of foods. It may take 24 hours or more in summer, etc.

Do not put ice cream, uncooled foods or perishable foods in it until the inside of the refrigerator is cooled well.

- Perform "Ice Maker Cleaning" when using the automatic ice making function for the first time. → Pg.66
- A series of ice making operation will start automatically after the inside of the refrigerator is cooled well. (When using for the first time, it may take 24 hours and more to make ice.)

Notice

- After the power plug is inserted, the cool air flap continues to work for about 2 minutes to check the state of the cool air flap (it may sound louder than usual, but it is normal).
- It may smell of plastics in the beginning when you start to use. Keep the room well-ventilated. Such smell will disappear gradually.

Caution

- If you wish to install the refrigerator in a hot spring area exposed to sulfide gas, you may need to apply anti-rust treatment to the piping. Contact your dealer in advance. Failure caused by sulfide gas will not be covered under guarantee.
- Do not peel off the seal on the back or plastics at the lower part of the side.
- When a magnet or suction cup is attached on the side of the body or the surface of a door, it may leave a mark.

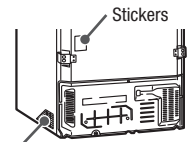

Plastic parts - Left/Right

6

Open the Auto Door. ※ Only for R-E6800X type

After inserting the power plug and touch the Open Button for the Auto Door, the door will be opened. → Pg.48

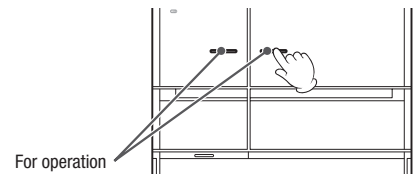

For operation

Before Use

Transporting your refrigerator (transport for moving)

1

Take out foods or ice.

2

Pour off the water from the water supply container/ice tray.

3

Pull off the power plug.

No problem just before moving.

4

Remove the leg covers, and raise the adjustable mounts.

5

Use a tape to secure the door/power cord.

6

Place a sheet or cloth for protection when moving / transporting it.

To prevent damage to the floor material or water from spilling out.

7

Place a sheet or cloth for protection first, and then lay it back to drain water.

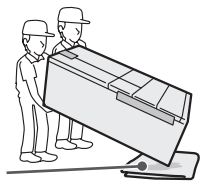

Such as old cloth

8

Make sure to hold the handles when carrying it with 2 persons or more.

Do not lay it down horizontally for transportation (which may cause failure of the refrigerator).

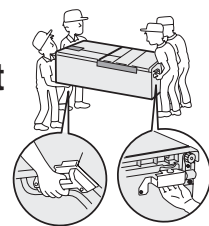

9

See "Preparation before use" for installing the refrigerator in a new location. → Pg.46

Auto Door

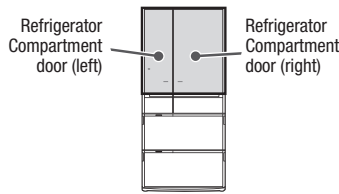

You can open the door easily by touching the door lightly with your fingers thanks to the Auto Door function. (Only for R-E6800X type)

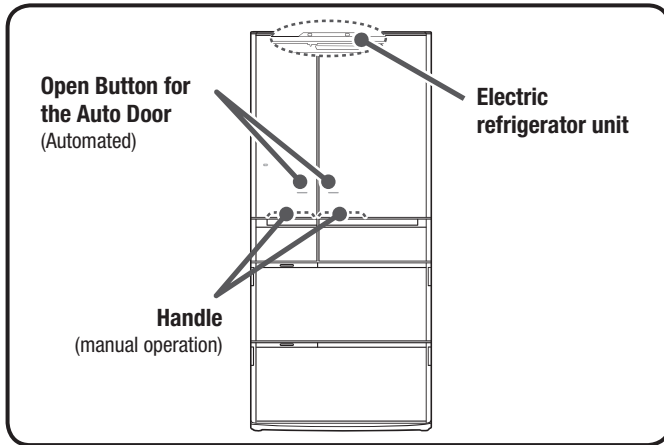

Caution

- When an infant child may use the Auto Door to make mischief, please stop the Auto Door function.
- Use fingers to operate the Open Button for the Auto Door.
- Do not operate the Auto Door when another person is in front of the refrigerator (which may lead to personal injury unexpectedly by the opening door).
- Be sure to unplug the power plug before cleaning the Auto Door.
- Do not put any item on the refrigerator.

Setting the Auto Door

- 1

Touch MENU button on the Open Button to turn on the indicator lamp.

All indicator lamps turn on, and then the current settings are displayed.
- 2

Hold down the Fridge button for 3 seconds or more until the preset sound is heard.

Auto Door function changes to "On" or "Off".
Auto Door function is set to "On" before shipping.
If you stop Auto Door function, set it to "Off".

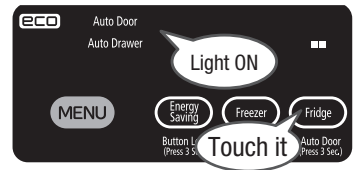

Auto Door function	"On" (Open Button for the Auto Door is enabled)	"Off" (Open Button for the Auto Door is disabled)
Indicator lamp of the "Auto Door"	On Auto Door	Off
Preset sound	Long beep	2 beeps

- Notice
- Hold the handle with your hand to open the Auto Door when it is set to "Off".
 - You can't stop the Auto Door function of either "Refrigerator Compartment door (right)" or "Refrigerator Compartment door (left)" only.

Using the Auto Door

When touching the Open Button for the Auto Door, the operation sound is heard, and then it will open automatically.

When closing it, use the handle with your hand to do so (not electrically operated).

How to open the Auto Door	Top view of the refrigerator Opening one door on either side	Top view of the refrigerator Open both doors at a time
How to operate	Touch the Open Button of the door to be opened	Slide your finger from one edge of the Open Button to the other. (Doors will open in turn from the side you touch.)
Operation sound of the Auto Door	1 beep	Long beep

- Notice
- Auto Door is the function to reduce the load at the opening operation when opening the refrigerator door. Opening angle of the door may vary or the door may go back a little after it is opened automatically depending on installation conditions of the refrigerator or how beverages or foods are stored in the door pocket, but this is not malfunction.
 - Auto Door won't be opened when either "Ice Compartment" or "Upper Freezer" is opened.
 - After touching the Open Button for the Auto Door, the operation sound may be heard when opening the door, but this is not malfunction.
 - If the Open Button for the Auto Door is wet or dirty, it may not respond. Use a wet cloth to wipe off dirt, and then wipe it with a dry cloth.
 - If you touch the Open Button of the Auto Door and its neighboring part at the same time, or you touch it for about one second or more, the Auto Door may not be opened automatically.

Auto Drawer

Auto Drawer function helps you to pull out the case easily even if it is heavy with plentiful foods in.

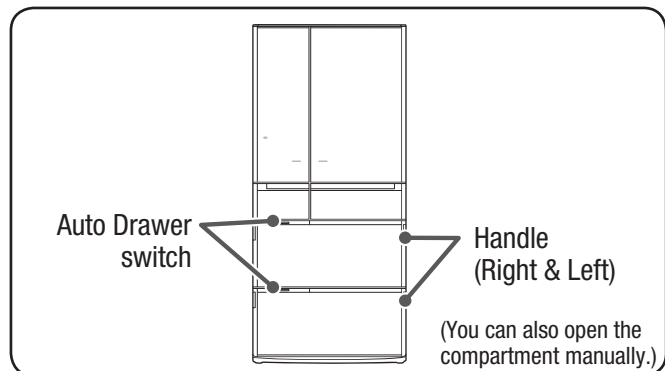
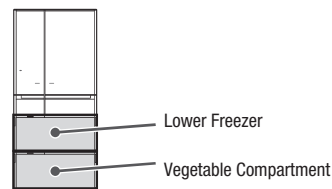

Warning

- **Stop the Auto Drawer function if there is a chance that small children play with the Auto Drawer.**
- Do not hold any portion of the door other than the handle. (This can cause pinching of fingers, which could result in injury.)
- **Do not bring your foot too near the refrigerator when you press the Auto Drawer switch of the vegetable compartment. (You may knock your foot against the door and may cause injury)**
- Operate the Auto Drawer switch with your hand.
- Make sure to disconnect the power plug from the power outlet before starting maintenance of the Auto Drawer.

Set the Auto Drawer

1 Touch button on the Open Button to turn on the indicator lamp.

All indicator lamps turn on, and then the current settings are displayed.

2 Hold down the button for 3 seconds or more until the preset sound is heard.

Auto Drawer function changes to "On" or "Off".
Auto Drawer function is set to "On" before shipping.
If you stop Auto Drawer function, set it to "Off".

Auto Drawer function	"On" (Auto Drawer switch is available)	"Off" (Auto Drawer switch is not available)
"Auto Drawer" indicator lamp	On Auto Drawer	Off
Preset sound	Long beep	2 beeps

- Notice**
- When you set Auto Drawer to "Off", pull out the handle on the right/left manually to open.
 - It is impossible to stop only one Auto Drawer function of either "Lower Freezer" or "Vegetable Compartment".

Auto Door / Auto Drawer

Using the Auto Drawer

The compartment opens and LED lamp is illuminated by pressing the Auto Drawer switch with your hand.

When you close it, push the handle on the right/left to close.
(Closing of the compartment is not electrically operated.)

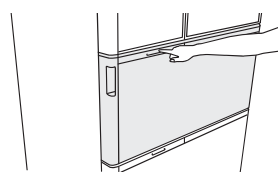

- Notice**
- This function is to reduce an initial load when pulling out the Auto Drawer. The Auto Drawer to be pulled out by approx. 15 cm or more. The length may vary depending on installation conditions of the refrigerator, or the door may go back a little after the door is opened automatically, but it is normal.
 - "Lower freezer" and "vegetable compartment" cannot be electrically opened at the same time.
 - When one of the "lower freezer" and "vegetable compartment" is open, the Auto Drawer function does not work.
 - A sound is heard when you press the Auto Drawer switch. This is not abnormal.
 - Auto Drawer function doesn't work when Auto Drawer function is "Off" or in case of power outage.
 - Wipe off spilled liquid soup and others on the Auto Drawer switch immediately.
Or Auto Drawer switch may fail to work, causing the door open disorderly.

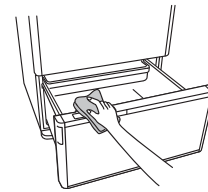

REFRIGERATOR COMPARTMENT

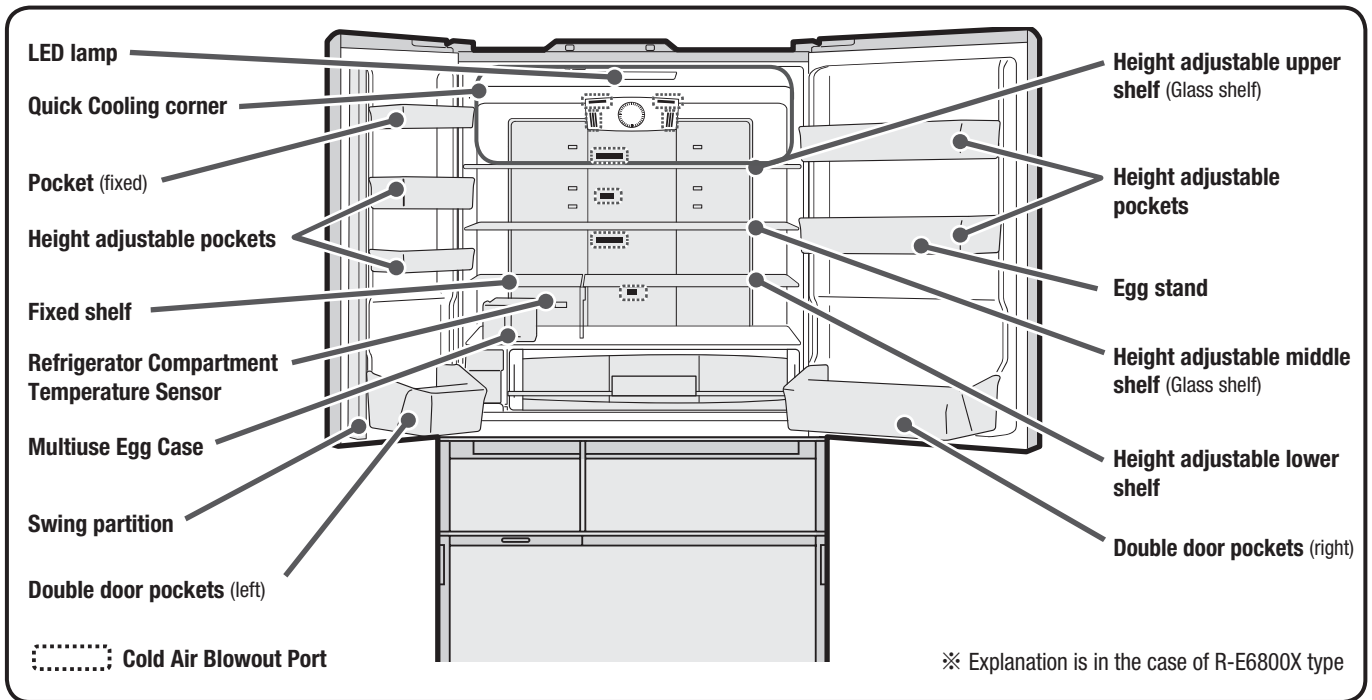
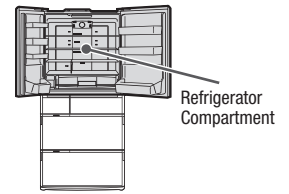

Caution Cold Air Blowout Port

- High moisture foods / canned beverages may be frozen or burst if they are placed around the Cold Air Blowout Port.
- Store hot foods in the Quick Cooling corner or on the Height adjustable shelf. If it is placed near the temperature sensor, the temperature of the Refrigerator Compartment may get too lower or dew may adhere to the panel at the back of the Refrigerator Compartment.
- Do not put too much force on the door by opening it too much or leaning on the opened door, which may cause damage to the door.

Adjust the height of a pocket/shelf

You can adjust the position of the pocket and the shelf depending on size of foods or beverages.

For how to remove/attach, see [→ Pg.68](#) .

■ Height adjustable pockets

■ Height adjustable shelves (upper/middle)

You can adjust the position of them depending on the height of foods or beverage.

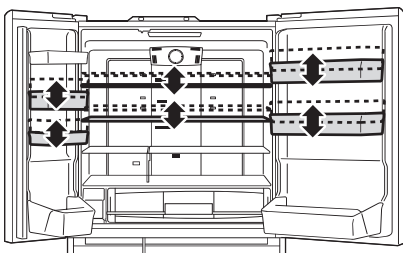

■ Height adjustable lower shelf

You can adjust them in three-stages.

- State in shipping
- Storage of pans, etc.
- Storage of milk carton, etc.

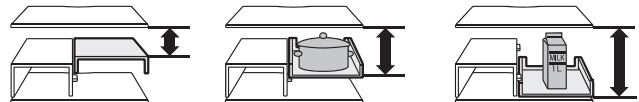

- Caution**
- Avoid a high impact on the glass shelf (broken glass may cause injury).
 - Be careful to attach the glass shelves because they are heavy.

CAUTION

■ To open the door

- Do not hold the swing partition to open the door.
(It may make it impossible to open the door.)

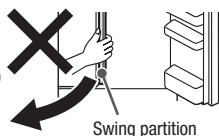

■ To close the door

- Do not close the door with the swing partition erected.
(It may make it impossible to close the door completely.)

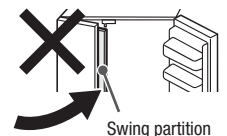

Using a multiuse egg case

This can hold eggs and others in it and be put in the refrigerator compartment.

10 eggs can be stored in this case. The egg pack with eggs in it can be stored as it is.

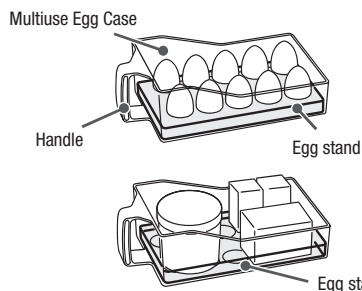

When the egg stand is turned over, it can be used for small sized food.

Caution

- Hold the carry handle securely when handling it.
- Do not stack food, otherwise they may drop.
- Do not put tall food in because they may fall down.
- Do not make ice with this container. A container may get damaged.
- If placed around the cold air blowout port, foods with a high water content, canned beverages / eggs may be frozen or burst. Keep and use them away from the cold air blowout port.

Adjusting temperature in a refrigerator compartment

1 Touch **MENU** button on the Open Button to turn on the indicator lamp

All indicator lamps turn on, and then the current settings are displayed.

2 Touch **Fridge** button to set the temperature as you like.

Each time you touch the button, the corresponding indicator lamp changes in the order shown in the figure on the right.

The temperature is set to "■■■" before shipping.

- Select "■■■" in ordinary usage. The temperature may change depending on the operation states.
- If you adjust the temperature more finely. (→ Pg.63)

Notice

- The temperatures of the Vacuum Compartment also change if selecting "■■■" or "■".
- Temperature of the door pocket is set slightly higher than the one in the figure on the right.

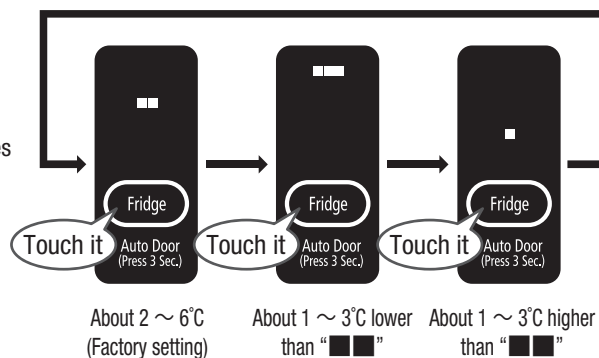

About 2 ~ 6°C
(Factory setting)

About 1 ~ 3°C lower
than "■■■"

About 1 ~ 3°C higher
than "■■■"

※ The above temperatures are standard values in the Refrigerator Compartment under the condition that the refrigerator is stable with no food stored and the door closed, at ambient temperatures of 30°C.

Cooling food Quickly (Quick Cooling)

1 Place the foods in the Quick Cooling Corner.

The food cools more quickly if it is placed at the center part near the interior wall. (the front of the Cold Air Blowout Port)

Caution

- Place canned beverages and foods with a high water content apart from the cold air blowout port. They may be frozen or burst.

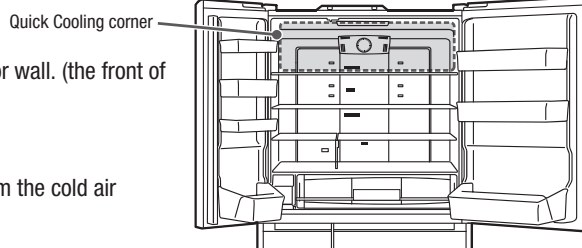

2 Touch **MENU** button on the Open Button to turn on the indicator lamp.

All indicator lamps turn on, and then the current settings are displayed.

3 Touch **Powerful** button to turn on "Fridge" indicator lamp.

"Fridge" indicator lamp is turned on during the "Fridge" operation, and other lamps will be turned off in about 40 seconds.

The operation will end automatically in about 50 minutes and "Fridge" indicator lamp will turn off.

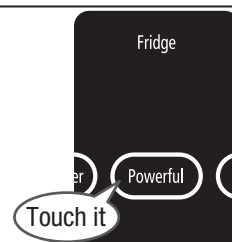

To cancel it Touch **MENU** button to turn on the indicator lamp, and then touch **Powerful** button to turn off "Fridge" indicator lamp.

VACUUM COMPARTMENT

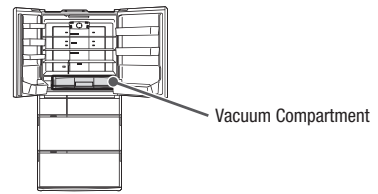

Photocatalyst & LED light Due to lights from LED lights and the effect of photocatalyst, odorous substances of foods and ethylene gas from vegetables are converted into carbon dioxide to restrict activities of the enzymes. The LED light illuminates the Vacuum Case when a door of the refrigerator is opened.

Antioxidation Fresh Cassette
Be sure to peel off the seal before use. (→ Pg.47)
 Antioxidant constituents and hot flavor are released from the Cassette when the Vacuum Compartment is in a vacuum state so as to preserve nutrients and keep freshness.
 ※ It is not required to replace it periodically.

Vacuum Pump

Vacuum release valve (in blue)
 Raise the handle to unlock it. The vacuum will be released by the vacuum release valve. Hissing sound is generated when releasing the vacuum.

Handle

Vacuum Case
 (With an aluminum tray)

When opening/closing the door of the Vacuum Case

When opening the door

1 Pull up the handle to unlock.

2 Pull out the Vacuum Case.

The Vacuum Case cannot be opened due to the vacuum state when the hissing sound can still be heard. When the hissing sound stops, pull the handle towards you to open.

Caution

If you pull out the Vacuum Case without opening the door on the left/right, it may cause damage to parts.

When closing the door

1 Push the Vacuum Case back to the end.

Caution

If you close the Refrigerator Compartment door with the Vacuum Case opened, parts or foods may be damaged.

2 Press down the handle to lock.

Fully press down the handle to lock the door. Hold down the handle to the end. Or the Vacuum function will not work properly.

Caution

If you close the door of the refrigerator with the handle unlocked, it may cause damage to parts and gasket gap.

Notice

- The vacuum pump is activated when the door of the Refrigerator Compartment is closed, with the Vacuum Case closed and the handle locked.
- Sound occurs upon start of the vacuum pump, which is a normal event.
- The vacuum pump requires about 3 minutes to produce a vacuum after its activation. No hissing sound comes out when the Vacuum Case is opened within 3 minutes. Always wait for 3 minutes or longer before checking vacuum state.
- Adopting indirect cooling, the Vacuum Compartment requires longer time than other compartments to cool food.
- In the dark, you may see the light of LED light through the door gaskets of the Refrigerator Compartment while the photocatalyst function works.

Request

- If the antioxidant Antioxidation Fresh Cassette is dirty, wring out a wet cloth and use it to wipe it off.

Caution

- Do not rinse the Antioxidation Fresh Cassette in water. In case it is rinsed, dry it completely before use.
- Do not smell the Antioxidation Fresh Cassette directly. It may be irritating to the nose.
- Do not disassemble the Antioxidation Fresh Cassette.

Change the settings of the Vacuum Compartment

1 Touch **MENU** button on the Open Button to turn on the indicator lamp

All indicator lamps turn on, and then the current settings are displayed.

2 Touch **Vacuum** button to change the settings as you like

The display switches in sequence as shown below every time the button is touched. The temperature is set to “-1°C” before shipping.

Caution

- The display will be turned off after about 40 seconds for energy saving, but the function that is set once will remain effective.

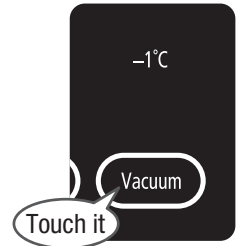
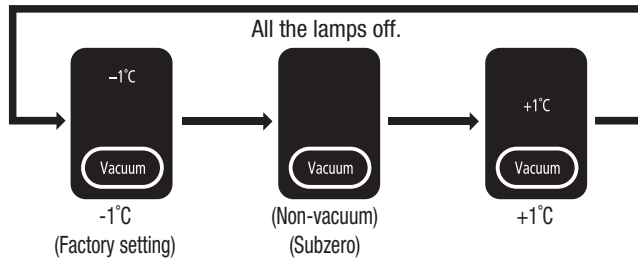

※ The above values are obtained with an ambient temperature of 30°C, the temperature in the Vacuum compartment in a stable state with no food stored and no door opened.

Settings and food stored

Vacuum	-1°C (About -1°C)	<p>The following foods should be stored at “-1°C” setting.</p> <ul style="list-style-type: none"> ● Meat, processed meat ● Fish, seafood, boiled fish paste <p>This setting is also suited for thawing. Foods high in water content may freeze.</p>	<p>Food and container for which care needs to be taken during storage</p> <ul style="list-style-type: none"> ● Food contained in a sealed bag The bag may be inflated during storage, which could result in crushing of other stored food. <p>Vienna sausage, sliced cheese etc.</p> <ul style="list-style-type: none"> ● Plastic airtight container The lid of the container may become loose or may not stay in place during storage. Be careful when you take out the container.
Vacuum	+1°C (About +1°C)	<p>The following foods should be stored at “+1°C” setting.</p> <ul style="list-style-type: none"> ● Dairy products Yogurt, cheese etc. ● Food which form air bubbles inside if frozen Tofu, konnyaku, deep-fried tofu, string konnyaku, boiled eggs etc. ● Precut vegetables and fruits Fresh vegetables such as salad / macrophyll & fruits such as orange / kiwi fruit ● Others Vegetables in sealed bags or airtight containers, coffee beans, tea leaves etc. 	<p>Food which are not suitable for storage</p> <ul style="list-style-type: none"> ● Vegetable sensitive to low temperature The surface of the vegetable may deteriorate due to low temperature. Store it in the Vegetable Compartment. <p>Okra, asparagus, ginger, and green pepper</p>
Vacuum OFF	OFF (Non-vacuum) (About -1°C)	<p>The vacuum function/photocatalyst function is disabled. This setting is recommended to store food in “sealed bags” or “sealed containers” which requires caution in storing. Foods high in water content may freeze because this is a regular ice-temperature compartment.</p>	

Notice

- The vacuum effect will not be changed even if foods are wrapped.

Caution

- Foods high in water content may freeze if ambient temperature is low.
- The temperatures of the Vacuum Compartments also change if the temperature of Refrigerator/Freezer Compartment is set to “■■■■” or “■”.

Request

Dew and/or frost may occur in the Compartment due to moisture contained in foods or in the air because the Vacuum Compartment is sealed.

- Wipe dew and/or frost off with a soft cloth wet by lukewarm water.
- Wipe water or soup spilled in the compartment soon, if any.
- ※ A water droplet and/or frost won't have a bad impact on performance.

Dew and/or frost



FREEZER COMPARTMENT

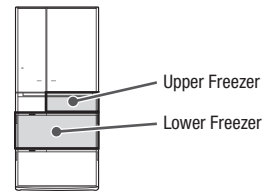

Using the Upper Freezer

With Quick Freezing System, all the moisture, natural nutrients and good flavor in the foods are preserved in an instant. → Pg.55

It is recommended to use this compartment when freezing meat and/or fish quickly.

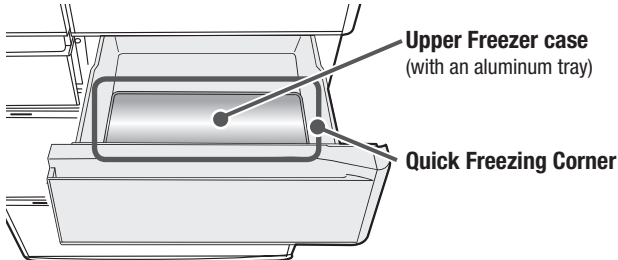

Stored foods

Upper Freezer case	Freezing bag, airtight container, etc. Space for small-item and frozen food, etc.
	Quick Freezing Corner When freezing meat or fish quickly

Using the Lower Freezer

3-layer freezer case provides you with large storage space compartment and convenient reach of your freeze food items.

It is suitable for storing the food preserved for a long time and the food that melt easily such as ice cream.

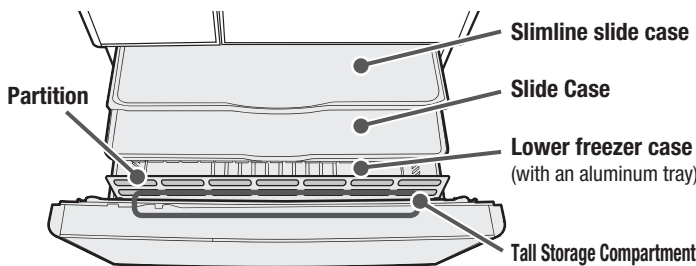

Stored foods

Slimline slide case	Small-item and frozen food, etc.
Slide Case	Freezing bag and airtight container etc.
Lower freezer case	Frozen food and bread Ice cream etc. Tall Storage Compartment PET bottle for freezing, etc.

- Move the aluminium tray in the Upper Freezer to the left side of the Slimline slide case, as it can be used as the Quick Freezing Corner.

Caution

- Do not remove the Slimline slide case and the partition.

Caution on how to store foods

Store foods properly depending on the height of them.

The door will not be closed completely, which leads to inefficient cooling action, and which may cause food deterioration or damage to the cases. Keep the food off from the upper slimline case and/or the slide case.

Guideline for height

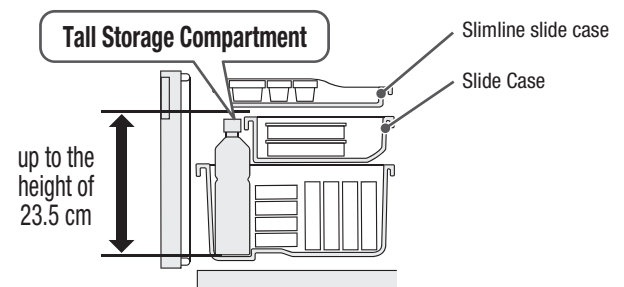
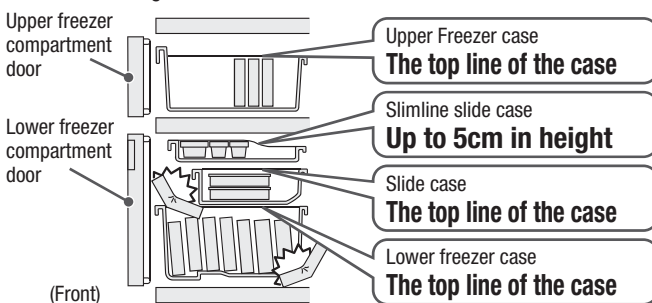

- Do not store any 500ml PET bottle in the Slimline slide case. It may not be taken out because it expands when it is frozen.
- Do not use with the slide case removed. Food may drop to the inner part of the case, and as a result, the door may not close completely.

- When storing tall food in the tall storage Compartment, make sure that it does not contact with the Slimline Slide Case and/or the Slide Case.
- Store only food which can be frozen such as PET bottle which can be stored in freezer.

Adjust the temperature of the freezer compartment

1 Touch **MENU** button on the Open Button to turn on the indicator lamp.

All indicator lamps turn on, and then the current settings are displayed.

2 Touch **Freezer** button to set the temperature as you like

Each time you touch the button, the corresponding indicator lamp changes in the figure on the right:

The temperature is set to “■■■” before shipping.

※The temperatures are standard values under the specific condition (the surrounding temperature of 30°C, no food stored, door closed and the temperature in the refrigerator is steady).

- Select “■■■” in ordinary usage. The temperature may change depending on the operation states.
- For more information about the panel for operation. → Pg.63

Notes: For the Freezer Compartment (“■■■■” Lower temperature freezing), food is stored at a lower temperature than the conventional freezing temperature. The energy consumption is approximately 20% higher than that for the conventional freezing operation.

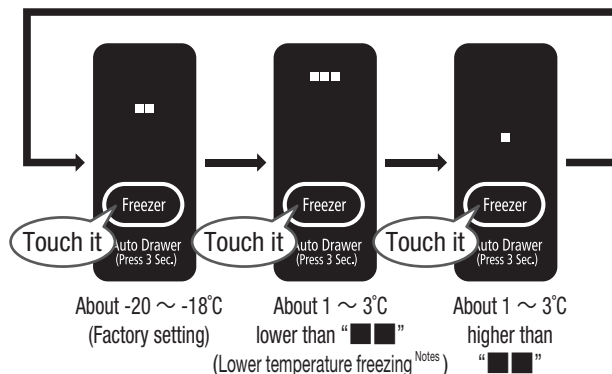

Notice

- If operating the refrigerator for a long time with the Freezer Compartment “■■■■” selected, ice cream etc. may become hard or it may take a longer time to thaw food.

Quickly freezing foods (Quick Freezing)

1 Place the food wrapped with plastic film on the aluminium tray in the upper Freezer.

Dividing food into small pieces not only makes them freeze soon, but also be taken out easily.

Notice

- Move the aluminium tray in the Upper Freezer to the left side of the Slimline slide case in the Lower Freezer, as it can be used as Quick Freezing Corner.

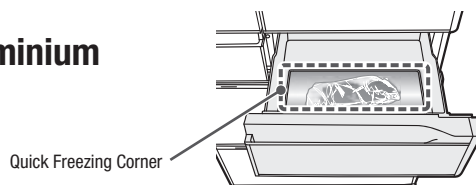

2 Touch **MENU** button on the Open Button to turn on the indicator lamp.

All indicator lamps turn on, and then the current settings are displayed.

3 Touch **Powerful** button to turn on the “Freezer” indicator lamp.

“Freezer” indicator lamp continues to be lit during the operation, and other indicator lamps will be turned off in about 40 seconds.

The operation will end automatically in about 120 minutes, and “Freezer” indicator lamp will be turned off.

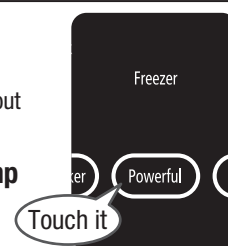

To cancel it Touch **MENU** button on the Open Button to turn on the indicator lamp, and touch **Powerful** button to turn off “Freezer” indicator lamp.

Notice

- Freezer compartment is cooled preferentially in the “Freezer” operation. For that reason, temperature of the Refrigerator Compartment may rise if opening/closing the Refrigerator Compartment door frequently.
- Warm food such as rice can be easily frozen by this function. Make sure that you never burn yourself when putting hot food in. It is recommended to put it in after it is cooled down to the temperature where you can hold it with your hand.
- Touching **Powerful** button again within 60 minutes after the end of the “Freezer” operation, the lamp is illuminated, but the “Freezer” operation does not start. The operation will start after 60 minutes pass.
- Make sure to wrap the food with plastic film to prevent it from sticking on the aluminium tray.

ICE COMPARTMENT (AUTOMATIC ICE MAKER)

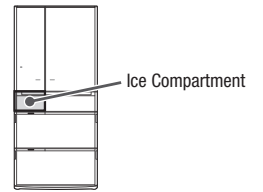

Water Supply Container
(Approx. 1.0 L)

Ice Case

Open Button

Ice Making buttons

How to make Ice

- 1** Touch **MENU** button on the **Open Button** to turn on the indicator lamp.

All indicator lamps turn on, and then the current settings are displayed.
- 2** Touch **Ice Maker** button to turn on "On" indicator lamp.
- 3** Take off the **Water Supply Container**.

When the "Water" indicator lamp is lit or the water level reaches to the "Add water line", replenish water.
- 4** Open the lid and add water.

Water level can not exceed "Container-full line".

※ Do not pour water into it beyond the full water line.
- 5** Replace the **Water Supply Container**.

Push it straight beyond the "Container set position" line completely.

Water will not be supplied until the water supply container is pushed to the end.

※ Water may spill out if the water supply container is inclined. Wipe off spilled water immediately.

Ice-Making starts automatically

Ice cubes are stored in the Ice Case. 12 pieces of ice cubes are made by one ice-making operation.

Notice

It may take longer time to make ice in the following cases:

- It is used for the first time (it may take 24 hours or more).
- It is set to the "Energy Saving" mode.
- The door is opened/closed frequently.
- Large volume of foods is stored in the refrigerator at a time.
- In case of power outage.
- With the low ambient temperature in winter, etc.
- After the ice tray is cleaned.
- When the door of the Freezer Compartment / Ice Compartment is not closed completely.
- When the temperature of the Freezer Compartment is set to "■".

Perform "Ice Maker Cleaning" when making ice for the first time or for the first time in a week or more. → Pg.66

Request

- **WARNING:** fill with potable water only.
- Water for ice making is according to your drinking standard. Quality of tap water may vary in different countries. Please check and verify with your local authority.
- Change water and clean the container at least once a week for hygiene purposes.
- If the ice made of mineral water containing a lot of mineral ingredients is put into water, white powder may come out, however this is due to those mineral ingredients and harmless.
- Furthermore, these types of water are easily contaminated with bacteria. Please wash the container usually once 3 days.

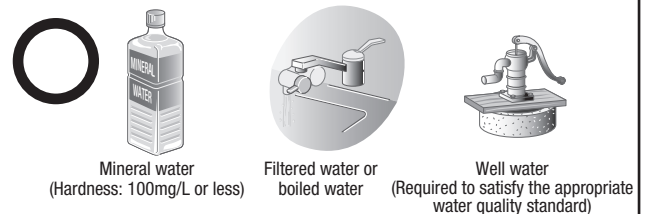

- Do not use the following ones because they may cause malfunction, deformation or sticking ice.



Quick Ice Making

1 Touch **MENU** button on the Open Button to turn on the indicator lamp.

All indicator lamps turn on, and then the current settings are displayed.

2 Touch **Ice Maker** button to turn on “Quick” indicator lamp.

Ice cubes are made in a shorter time than that of “On” operation.

12 ice cubes are made by one ice-making operation.

“Quick” indicator continues to be lit during the “Quick” operation. Other indicator lamps will be unlit about 40 seconds later.

“Quick” operation ends automatically in about 7 hours, and it is changed to “On” mode.

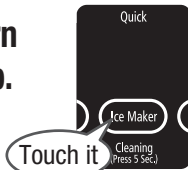

Stop Ice Making

1 Touch **MENU** button on the Open Button to turn on the indicator lamp.

All indicator lamps turn on, and then the current settings are displayed.

2 Touch **Ice Maker** button to turn on “Off” indicator lamp.

Auto Ice Making is stopped and no ice cubes are made.

※ If you set to “Off” for 1 week or more,

maintain the Automatic Ice Maker. → Pg.66, 67

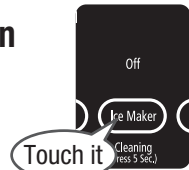

Notice

- “Off” indicator lamp won't turn off.

Water Supply indicator

“Water” indicator lamp comes on when water in the water supply container is getting low. Replenish the container with water.

- While the “Water” indicator lamp is on, the Ice Making function doesn't work even if the “On” and “Quick” is set.

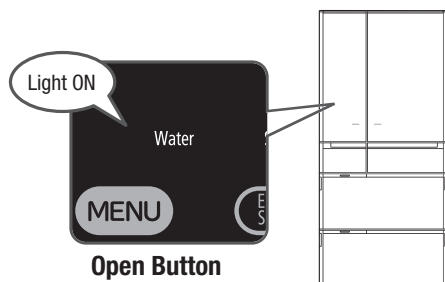

Notice

- “Water” indicator lamp turns off once (for up to 3 hours) when the left door of the Refrigerator Compartment is opened and closed while the indicator lamp is on, and it turns on again if no water is added to replenish the container.
- “Water” indicator lamp remains off when “Off” is selected for automatic ice making.

Caution

- “Water” may come on regardless of water level if the water supply container is not placed properly. Push in the container straight and completely if the indicator lamp comes on.

When the “On” indicator lamp is blinks

The ice tray may come into contact with foods within the Ice Case.



Request

Empty out the Ice Case once, and then start the “Ice Maker Cleaning”. → Pg.66

- Do not store any food such as frozen food other than ice in the Ice case when making ice automatically. (Otherwise, it may not make ice, or the door may not open or parts may damage because the food interferes with the parts of the Automatic ice maker.)

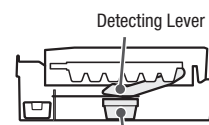

Is any frozen food stored in the inner part of the ice case?

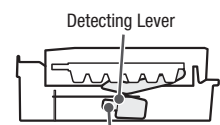

Is the Ice scoop placed in the given place?

Stored ice amount and ice-making time of the Ice Case

Stored ice amount	Normal operation	About 120 pcs
	Ice is leveled	About 150 pcs
Required time for an ice making operation	Normal “On”	About 110 minutes ~ 140 minutes
	“Quick”	About 80 minutes

※ The above values are obtained with an ambient temperature of 30°C, the temperature in each compartment set to “■” and no door opened/closed.

Notice

- Limit line of stored ice amount represents the guide line of stored ice amount when the Automatic Ice Maker makes ice with ice leveled. If the ice is stored partially, the detecting lever may contact the ice early. As a result, the Automatic Ice Maker may stop making ice before the amount of stored ice is enough.

Request

- Gently open and close the door of the Ice Compartment, otherwise ice may fall out of the ice case onto the lower freezer.

VEGETABLE COMPARTMENT

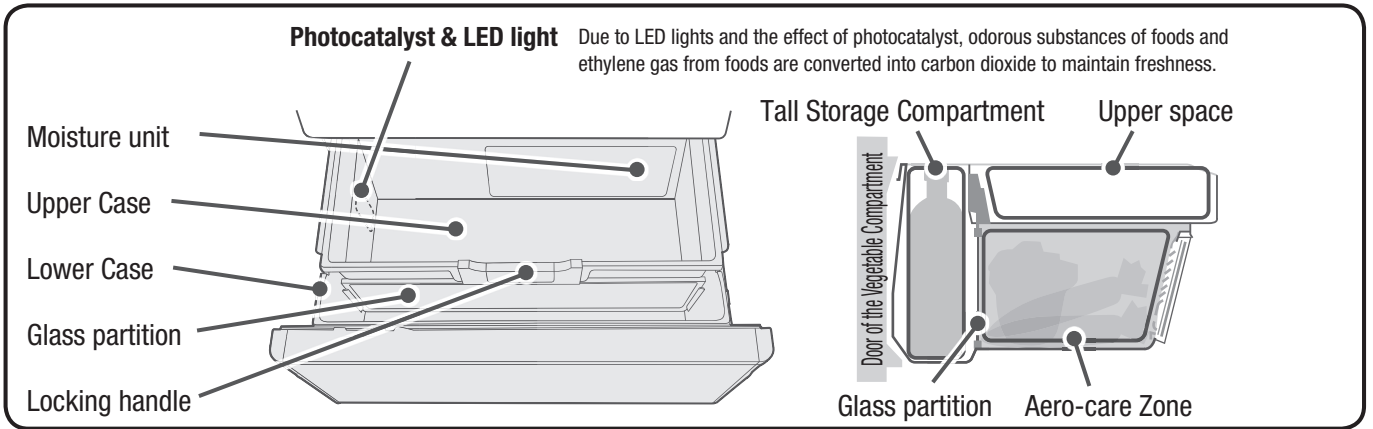
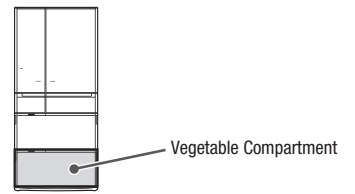

- Caution**
- Do not remove the moisture unit and photocatalyst from the lower case.
 - The glass partition can't be removed.

Stored foods

Upper space	Unfinished vegetables, small vegetables, fruits, etc.
Tall Storage Compartment	Tall vegetables, 2L PET bottle, etc.
Aero-care Zone	Leaf vegetables (spinach, Japanese Mustard Spinach etc.), large vegetables (cabbage, lettuce), etc.

- Request**
- Since the humidity in the Vegetable Compartment is high, dew may be formed around the Upper Case, Upper Case, on the ceiling of the Vegetable Compartment and surface of vegetables, depending on the volume or type of vegetables, but it is normal. Among others, the humidity is higher within the Aero-care Zone, which results in more amount of dew condensation. Accumulated water may cause damage to food, so use a soft cloth to wipe it off.
 - If the moisture unit is blocked by a bag or container of foods, dew is formed easily. Move out the bag or container of foods from there.
 - If you feel uneasy about dew condensation, wrap the foods.
 - When storing dried foods such as rice, laver and others in the Vegetable Compartment, put them in a sealed container (bag) and then place them in the Vegetable Compartment. Dried foods may absorb the moisture.

Caution on how to store foods

Store foods properly depending on the height of them.

The door will not be closed securely, which leads to inefficient cooling action. Or, it may cause damage of food or each case. Keep foods away from the bottom of the Upper case.

Guideline for height

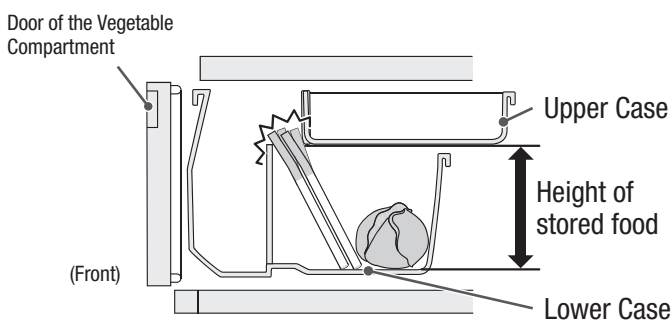

- **Do not pile up foods higher than the case.**
 - The door will not be closed securely, which leads to inefficient cooling action.
 - It may cause damage of food, case or glass partition.
 - Upper case doesn't be closed securely, so that the Photocatalyst Preservation may have no effect.
- **Place too many foods/beverages forcedly in the Tall Storage.**
 - Some PET bottle can't be stored, depending on its type.
 - Do not put too many foods, beverages, etc. in it. The glass partition may be broken.

Using the Aero-care Zone

When opening it

- 1 Push the lock handle at the center of the Upper case to slide it to the end.

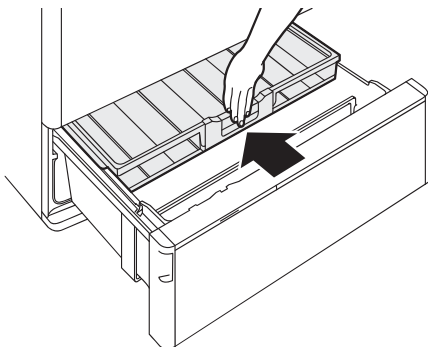

Caution

- The upper case won't slide to the end when you don't push the lock handle.

When closing it

- 1 Draw the lock handle at the center of the Upper case, and then slide it to the end to lock until it snaps.

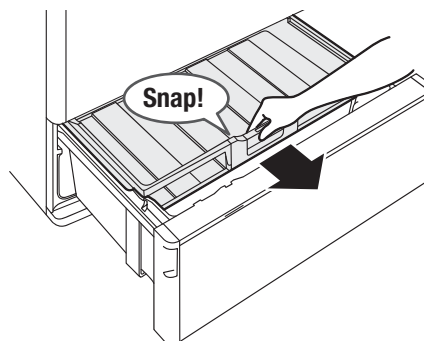

- ※ When the Vegetable Compartment door is closed, the Upper case goes back to the original position and is locked.

To cool it more [Vegetable Compartment (MAX)]

- 1 Touch **MENU** button on the Open Button to turn on the indicator lamp.

All indicator lamps turn on, and then the current settings are displayed.

- 2 Touch **Powerful** button to turn on "Veg".

Foods are stored under the temperature lower than usual (approx. 1 to 5°C rather than approx. 3 to 7°C.)

※ The above temperatures are standard values for the Vegetable Compartment under the condition that the refrigerator is stable with no food stored and the door closed, at ambient temperatures of 30°C.

Caution

- For energy saving, the display will be turned off after about 40 seconds, but the setting remains active until it is released.

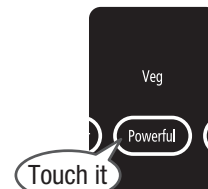

- To cancel it
- Touch **MENU** button on the Open Button to turn on the indicator lamp, and then touch **Powerful** button to turn off the "Veg" indicator lamp.

Notice

- If foods are kept in the "Veg" for a long time, vegetables high in water content may freeze. Release the setting of "Veg".
- You cannot set both "Veg" and "Fridge"/"Freezer" concurrently.
If it is switched to "Freezer"/"Fridge" mode during the "Veg" mode, it will not return to the "Veg" mode by itself after "Freezer"/"Fridge" is ended automatically. Set it to the "Veg" again.
- When setting "Energy Saving" mode during the "Veg" mode, the cooling function is shifted to weaker cooling effects from the "Veg". (→ Pg.60)
- When the ambient temperature is low, the temperature in the case may be lower.
- The temperature of the Tall Storage Compartment is a little higher than other spaces.

Request

- If vegetables sensitive to low temperature such as eggplant and cucumber, etc. are stored with the setting "Veg", they may have pits on the surface or get discolored. In that case, release the setting of "Veg".
- While it is set to "Veg", there may be more dew condensation in the Aero-care zone. If it is undesirable that dew adheres to the stored vegetables, release the setting of "Veg".

Vegetable sensitive to low temperature

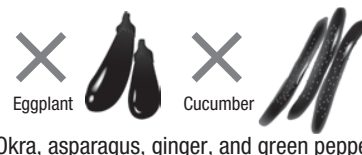

VARIOUS FUNCTIONS

Setting “Energy Saving” mode

Setting to “Energy Saving” mode (Save, Trip), the operation is changed to the following modes for energy saving.

Save (Energy Saving)	Save	<p>Save electricity by lowering the cooling capability of each compartment.</p> <p>Turning down the LED lights in the Refrigerator Compartment, the Vacuum Compartment and the Vegetable Compartment for power saving if the door of the Refrigerator Compartment is left open for more than 30 seconds.</p> <p>※ If it is set to “Save” mode, the function continues to work until the setting is released.</p>
	Trip	<p>Cooling down the inside of the refrigerator slowly leads to more reduction of power consumption.</p> <p>(Set it to this mode when you go out for a long time such as travel).</p> <p>※ When the door is opened/closed after it is set to “Trip”, it will be switched to “Save” mode.</p>

1

Touch  button on the Open Button to turn on the indicator lamp.

All indicator lamps turn on, and then the current settings are displayed.

2

Touch  button to change the settings as you like.

Each time you touch the button, the corresponding indicator lamp changes in the order shown below:
The Energy Saving mode is set to “Off” (all lamps off) before shipping.



Notice

- When both “Save” / “Trip” and “Quick (about 7 hours)” / “Freezer (about 120 minutes)” / “Fridge (about 50 minutes)” modes are set concurrently, “Quick” / “Freezer” / “Fridge” function is performed first, and it will be set to “Save” or “Trip” mode after the operations are completed. (→ Pg.51, 55, 57)
- When both “Save” / “Trip” and “Veg” modes are set concurrently, the cooling function will be weakened from the “Veg”. (→ Pg.59)
- When the temperature in the “Freezer Compartment” / “Refrigerator Compartment” is set to “■”, it will not be weakened so as to maintain the freshness of foods.

Caution

- Automatic temperature control lowers cooling loads, which may cause ice cream to get soft and frost to form on frozen food. It also requires longer freezing time and ice making time.

“eco” Operation indicator lamp

When the refrigerator is operated in a manner to reduce power consumption, such as Frost Recycle Cooling, the indicator lamp is automatically lit to indicate that the refrigerator is operating in the energy saving mode.

Notice

If [“eco” Operation indicator lamp] isn’t illuminated, check the following things.

- Immediately after it is installed, or plentiful foods are stored at a time
- If the door is frequently opened / closed
- If the door is not closed completely because any food/bag is wedged between the door and the body of the refrigerator.
- “Freezer,” “Fridge,” “Quick” or “Veg” is set.
- The ambient temperature of the refrigerator is about 35°C or higher.

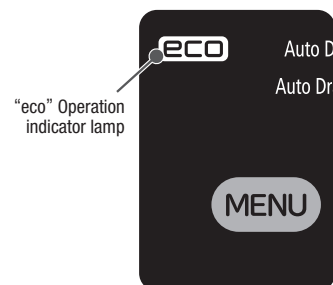

Locking the Open Button

This can prevent erroneous operation of the Open Button or misuse by children.



When this indicator lamp  (Lock of the Open Button) is illuminated, any other portion of the Open Button will not be activated by touching it.

1 Touch button on the Open Button to turn on the indicator lamp.



All indicator lamps turn on, and then the current settings are displayed.

2 Press down button 3 seconds or more until the preset sound is heard.

Lock of the Open Button is changed to "On" or "Off" . It is set to [] "Off" before shipping.

Setting of the Open Button's lock	"On" (locked)	"Off" (unlocked)
"  indicator lamp"	On 	Off
Preset sound	Long beep	2 beeps

Notice

- Electric pulling-out operation will not be disabled even if the Lock function on the panel for operation is set as On. When stopping the setting of Auto Door and Auto Drawer (electrical drawer compartment), unlock the Open Button, and touch the  or  button for 3 seconds or more until it beeps twice. [→ Pg.48, 49](#)
- When connecting/disconnecting the power plug or after recovering from electric power failure, lock of the panel for operation may be released.

Door Alarm

When the door is opened for more than 1 minute, sound and light occur indicating the door is open as shown in the table below.

For R-E6800 type, no Door Alarm is installed in the Upper Freezer.

Duration when door is open	1 minute	2 minutes	3 minutes
Alarm sound	Long beep (3 beeps)	Long beep (5 beeps)	Long beep (continuously), Louder

- ※ When the door is left open for one minute or more, the indicator lamp blinks and the characters on the Open Button is illuminated.
- ※ From 30 seconds onwards with the door opened, the Door Alarm sounds only when the energy saving mode is set. (The indicator lamp blinks when the door is left open for one minute or more)
- ※ When the indicator lamp on the display area blinks due to the Door Alarm function, the Open Button will not be activated by touching it.

Door Alarm and volume adjustment of the operation sound

You can set the sound level of the alarm louder or no alarm sound.

1 Touch button on the Open Button to turn on the indicator lamp.

All indicator lamps turn on, and then the current settings are displayed.

2 Press down button for 3 seconds or more until the preset sound is heard.

The volume level of the operation sound is changed from "Standard" to "Louder" or "Sound off" . Repeat the change of settings to set the operation sound you like (see the table shown below). The sound is set to "Standard" before shipping.

Volume level	Standard	Louder	Sound off	Standard
Preset sound	—	→ 2 long beeps →	Long beep →	2 beeps

(Factory setting)



Notice

- It is impossible to adjust the volume level of either door alarm or operation sound only.
- When the Door Alarm is disabled, characters on the Open Button no longer blink.
- Even if the volume level is set to "Sound off" , the alarm of the Ice Maker Cleaning and the operation sound when the Auto Door and the Auto Drawer are set to "ON" will sound.
- When connecting/disconnecting the power plug or after recovering from electric power failure, it will return to the standard setting where the Door Alarm sounds.

VARIOUS FUNCTIONS (CONTINUED)

Set the condensation prevention heater to MIN. (Swing partition/Partitioning iron plates)

Setting the condensation prevention heater to MIN saves energy.

When dew is formed in the swing partition or the partitioning iron plates, set it to the standard.

The temperature settings for the swing partition and the partitioning iron plates can be adjusted by four levels (1 to 4), and level 4 is the most energy saving.

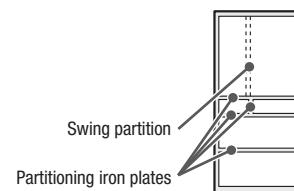

MIN setting of the heater	Standard	MIN setting level 1	MIN setting level 2	MIN setting level 3	MIN setting level 4	Standard
Preset sound	—	Long beep	Long beep (2 beeps)	Long beep (3 beeps)	Long beep (4 beeps)	2 beeps

(Factory setting)

Setting the swing partition

- 1** Open the door of the Lower Freezer Compartment.
- 2** Touch **MENU** button on the Open Button to turn on the indicator lamp.
All indicator lamps turn on, and then the current settings are displayed.
- 3** Press down **Powerful** button 3 seconds or more until the preset sound is heard.
The setting of MIN level of the dew condensation prevention heater will be switched.
Repeat the above-stated operation to set it to the level you prefer (see the table above).
- 4** Close the door of the Lower Freezer Compartment.

Setting the partition iron plate

- 1** Open the door of the Lower Freezer Compartment.
- 2** Touch **MENU** button on the Open Button to turn on the indicator lamp.
All indicator lamps turn on, and then the current settings are displayed.
- 3** Press down **Energy Saving** button 3 seconds or more until the preset sound is heard.
The setting of MIN level of the dew condensation prevention heater will be switched.
Repeat the above-stated operation to set it to the level you prefer (see the table above).
- 4** Close the door of the Lower Freezer Compartment.

Notice

- The setting will be returned to the standard when the power plug is disconnected and connected or power failure recovery takes place.

Fine adjustment of the temperature (Refrigerator Compartment / Freezer Compartment)

Temperature settings for Refrigerator and Freezer Compartments can be more finely adjusted by 11 levels. Usually it is recommended to use it at the setting of “■■■”.

1 Open the door of the Lower Freezer Compartment.

2 Touch **MENU** button on the Open Button to turn on the indicator lamp.

All indicator lamps turn on, and then the current settings are displayed.

3 Press down **Fridge** button for 5 seconds or more until 1 beep is heard.

4 Close the door of the Lower Freezer Compartment.

5 Touch **Fridge** or **Freezer** button to make an adjustment.

Each time you touch the button, the corresponding indicator lamp changes in the order shown below.

(Lighting Blinking Turned off)

Indication lamp											
Setting	MIN and under	MIN	→	→	→	MID.	→	→	→	MAX	MAX and more



To cancel Follow the operations shown in Step 1, 2 and 3.

2 beeps sound and you can set the temperature by normal step (3 levels).

MAINTENANCE (REGULAR CHECK)



Warning

- Make sure to unplug the power plug when maintaining the refrigerator.

■ When dirt is found

- Wipe off it immediately. It is recommended to clean the hidden places once a year.

Power plug Once or twice a year

1

Unplug the power cord from the outlet.

If the dust on the power plug remains not cleaned, it may cause a fire.

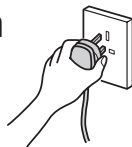

2

Check the following matters.

- Is any damage found on the power cord?
- Does the power plug become hot?
- ※ If there is any abnormality, please consult with your dealer about it.

3

Remove the dust and wipe it with a dry cloth.



4

Connect the power plug firmly to a power outlet.

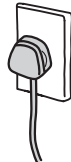

The back/floor of the refrigerator Once or twice a year

1

Pull the leg cover and remove it.

Push it in from the front when installing it.

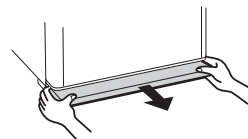

2

Float the Adjustable mounts from the floor and draw the refrigerator straight.

Lay the protection board etc. on the floor which can be easily scratched.

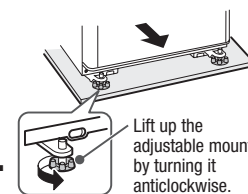

3

Wipe off dirt on the back of the refrigerator, duct on the side, wall and floor.

The back of the refrigerator easily becomes dirty because fine dust is accumulated on it by convection of air.

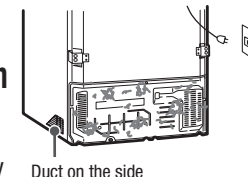

Surface of door Once a month

Wipe the surface of door using a soft cloth wet by lukewarm water, and then wipe off water with a dry cloth.

Remaining adhesives on glass surfaces, if any, can be removed clearly by using a plastic eraser to rub it and then wiping it off with a dry cloth.

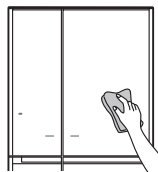

Each shelf/pocket/case Once per three months

Use a soft cloth wet by lukewarm water to wipe off.
For how to remove → Pg.68, 69

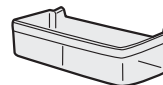

Request

- When the lower case of the Vegetable Compartment is washed with water, turn it upside down to drain water, and then wipe off water with a dry cloth. Don't use thick-pile toothbrush or scrubbing brush to wash. It may cause damage to case or moisture unit.

Door gaskets Once a month

Wipe it thoroughly because it can become easily dirty.

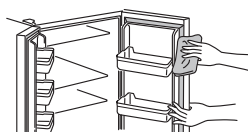

Caution

- Do not use the following items because it may cause damage and discoloration of the door, paintwork and plastic parts.
 - Alkaline and alkalescence detergent for kitchen, plate powder, powder soap, oil, hot water, scrubbing brush, acid, benzine, thinner, alcohol, and bleach, etc.
- When using a chemical dustcloth, follow the instructions of it.
- Make sure to wipe off spilled cooking oil, citrus fruits juice and food soup. Because it may cause damage and discoloration of the door, paint work and plastic parts.
- Do not wipe off lubricant applied to movable contact surfaces of cases and rails for the slide door.
- When a magnet or suction cup is attached on the side surface of the body or the surface of a door, it may leave some mark.
- When unplugging the power plug, the settings of the Open Button may be released. So check the settings.

Liquid receivers Once a month

Wipe off them if liquid collects and/or they becomes dirty.



Vacuum Compartment Once a month

1 Pull out the Vacuum Case.

For how to remove, → Pg.68

Be sure to remove foods contained in the Vacuum Case.

2 Remove the Antioxidation Fresh Cassette.

→ Pg.47

Wipe off dirt from the Antioxidation Fresh Cassette with a firmly wringed wet cloth.

3 Wipe off following parts with a soft cloth which is steeped in lukewarm water.

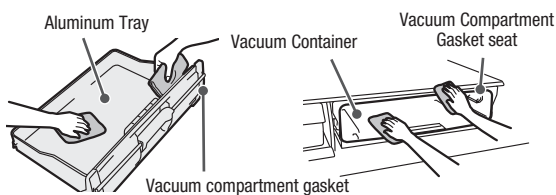

4 Attach the Antioxidation Fresh Cassette to the Vacuum Case.

5 Attach the Vacuum Case.

For how to attach, → Pg.68

Caution

- Do not rinse the Antioxidation Fresh Cassette in water.
- Do not touch the glass on the ceiling in the compartment (photocatalyst & LED light) with a finger or do not rub it with a dry cloth. Use a wet cotton-tipped stick, etc. to remove dirt, gently, if any.
- If detergents and others except lukewarm water are used to clean the vacuum compartment gasket, the vacuum compartment gasket may be damaged, deformed or change in color, which may cause the vacuum state unable to keep well.
- Loosened vacuum compartment gasket or loose-fitting door of the Vacuum Case may cause the vacuum state unable to keep well.

When the Vacuum Compartment Gasket is dirt

1 Remove the vacuum compartment gasket from the Vacuum Case.

Grasp the tab of the vacuum compartment gasket on the observer's upper right and remove it by hand carefully.

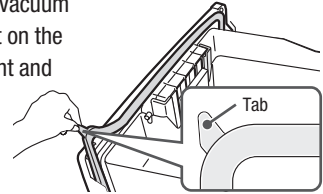

2 Rinse dirty portion in water using a soft sponge, etc.

※ Do not use the detergents, etc.

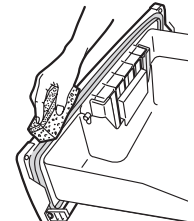

Wipe off dirt from the groove for attaching the vacuum compartment gasket.

3 Wipe off excess moisture with a dry cloth and dry it out naturally.

4 Attach the vacuum compartment gasket.

Align the tab to the notch accurately, and then combine them together.

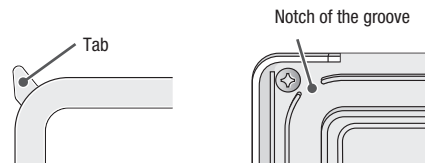

Auto Drawer

Clean the Auto Drawer unit when food falls onto or is caught in the upper part of the Auto Drawer unit and when liquid is deposited on the Auto Drawer unit.

1 Unplug the power plug.

2 Remove each case of the Lower Freezer or the Vegetable Compartment.

→ Pg.69

3 Remove all foods which drop or are caught in.

4 Wipe off deposited liquid soup using a soft and dry cloth.

Caution

- Make sure that water never splash to the Auto Drawer unit. Otherwise, it may cause malfunction.
- Do not disassemble the Auto Drawer unit. Otherwise, it may cause injury and/or malfunction.



Warning

- Make sure to disconnect the power plug from the power outlet before starting maintenance to avoid injury.

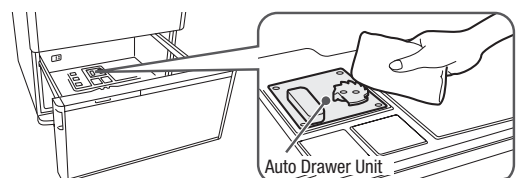

MAINTENANCE (CONTINUED)



Warning

- Do not place your hand in the mechanical section of the automatic ice maker.
(Rotation of the ice tray may cause injury.)

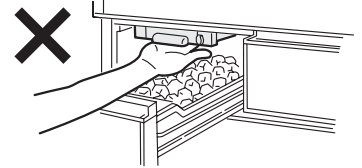

Ice Maker Cleaning

When using for the first time

When not used for more than one week

Preparation

Be sure to check the followings before starting the operation.

Water supply container

- Water is filled in it up to the limit line.
- It is set correctly beyond the tank set position line.

Ice case

- If there remains ice, remove it.

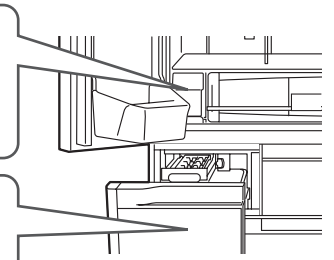

Go to the next step after checking them.

1

Close all the doors.

2

Touch **MENU** button on the Open Button to turn on the indicator lamp.

All indicator lamps turn on, and then the current settings are displayed.

3

Hold down **Ice Maker** button for 5 seconds or more until the alarm sounds.

When the 3 indicator lamps “Quick”, “On” and “Off” start to blink and alarm starts to sound, stop holding the button.

“Ice Maker Cleaning” (water supply route) starts (for about 4 minutes).

- The indicator lamp will flash and the buzzer will sound for about 4 minutes.
- “Ice Maker Cleaning” can’t be interrupted.
- If you open any of the refrigerator doors during Ice Maker Cleaning, the cleaning may not work properly. Do not open or close the door until cleaning is completed.
- Door alarm sounds even if alarm is disabled. (→ Pg.61)



4

Place a clean towel, etc. on the bottom in the Ice Case so that the cutout of the Ice Case can be blocked after the alarm and blinking of the indicator lamp end.

Place a water-absorbing towel on the bottom in the Ice Case to prevent trapped water during the ice maker cleaning from spilling out of the cutout of the Ice Case.

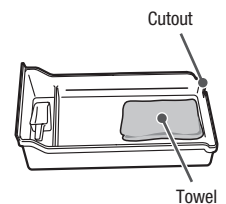

5

Wipe off water inside the Ice Case completely, and then set it to the Ice Compartment.

Remove the Ice Case, wipe off water inside the Ice Case, and then remove the towel. There is no problem with using water remaining in the water supply container, if any. After “Ice Maker Cleaning”, it is set to “On” mode, etc.



Water supply container Once a week

1 Remove the water supply container, and then the lid.

Take up the rear side of the lid toward in the direction of the arrow, and then remove it.

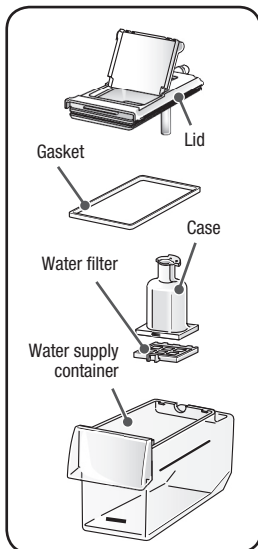
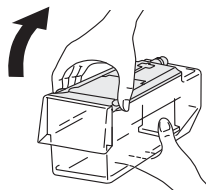

2 Remove the gasket from the lid and then the case.

Turn the case and remove it from the lid.



3 Remove the water filter from the case.

Pinch the tab of the water filter with fingers to unset it from the fork, and then remove the case.

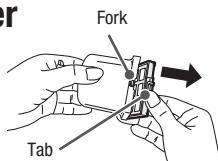

4 Rinse each part of the water supply container in water.

Wash it with a soft wash sponge etc. Do not use the detergents etc.

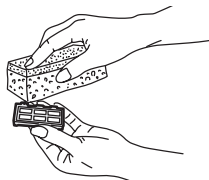

Request

- Dry out the water filter to prevent molds and gunk.

Notice

- Replace the water filter normally every 3 - 4 years.
→ Pg.74

5 Attach each part to the water supply container, pour water in and then set it.

Insert the lid from its rear side and close it in the direction of the arrow.

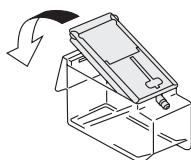

Notice

- Dechlorinated water such as mineral water, well water, filtered water, cool water after boiling and others tends to cause water stain / slime compared with tap water. So it is recommended to maintain once every 3 days.
- When the Ice Maker is not used for more than 1 week, dry out the water supply container, and then set it in place (dry out the water filter, among others).
When not used for more than 1 week, it is recommended to start Ice Maker Cleaning before use. → Pg.66

Ice tray Once or twice a year

1 Touch **MENU** button on the Open Button to turn on the indicator lamp.

All indicator lamps turn on, and then the current settings are displayed.

2 Touch **Ice Maker** button to turn on "Off" indicator lamp.

It stops water supply to the ice tray.

※ When "Off" indicator lamp blinks, wait for about 1 minute for it to turn on, and then follow the next steps.

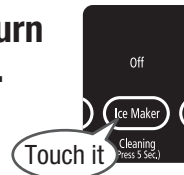

3 Open the door of the Ice Compartment, and take out the ice tray.

- 1 Push the level laterally.
- 2 draw the frame.
- 3 Raise the cover (▲ part) in the direction of the arrow.
- 4 Remove the ice tray from the frame.

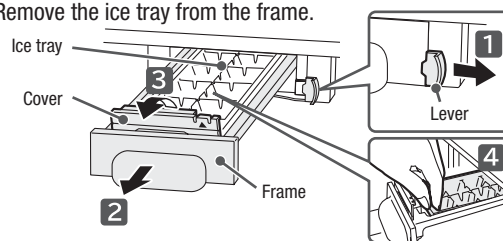

4 Empty the ice tray and wash it lightly in the stream.

Do not use a sponge / cleanser, etc. Be sure not to scarify.

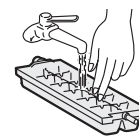

5 Open the Ice Compartment, and then attach the ice tray.

- 1 Set the ice tray
- 2 Hold down the cover to the end until it snaps.
- 3 Push the frame to the end until it snaps.
(Move the frame back and forth to check that it is fixed securely.)

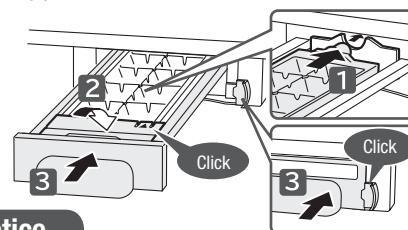

Notice

- When the frame for the ice tray cannot be pushed into the back, the motor that drives the ice-tray may have operated. Remove the ice tray once and then push the frame alone into the back, and then touch **Ice Maker** button with all the doors closed to turn on "Off". After a while, the ice-tray driving motor gets ready, allowing you to mount the ice-tray.

6 Touch **MENU** button on the Open Button to turn on the indicator lamp, and then touch **Ice Maker** button to turn on the "On" indicator lamp. Automatic Ice Making starts.

HOW TO REMOVE/ATTACH PARTS

Caution

- Before removing parts, take out all the foods on the parts.
 - Do not remove parts except the ones listed here.
- Please contact with a Hitachi customer service centre for cleaning such parts after removing them.

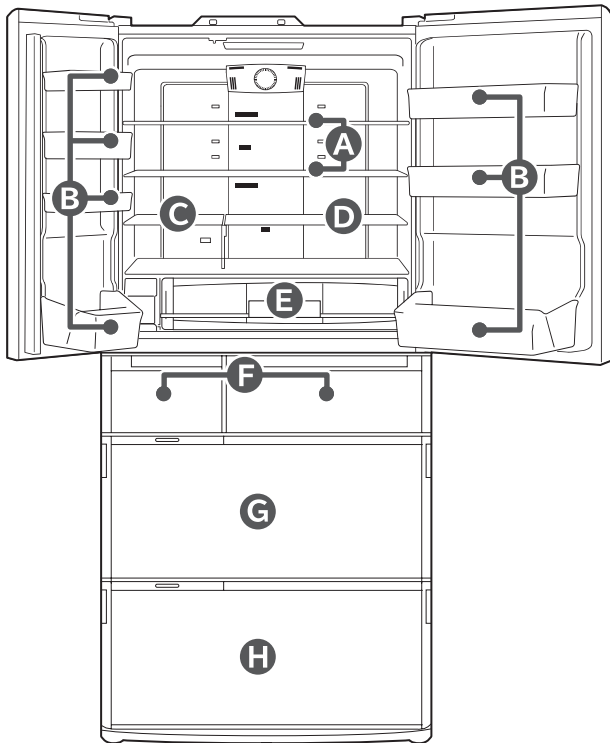

A Height adjustable upper and middle shelf (Glass shelf)

1 Slightly lift up the back of the shelf and draw it.

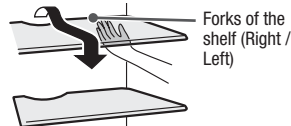

2 Raise the shelf as shown in figure, and turn it and remove it.

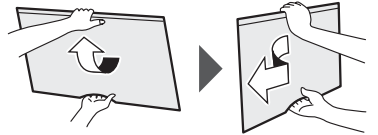

When installing the shelf, slide it until it reaches to the interior wall, then slightly lift up the back of the shelf and push it in. (hitch the forks of the shelf to the parts on the back of the shelf)

Caution

Door may damage if drawing the shelf without turning it. Be careful to attach/remove the glass shelf because it is heavy. If it drops, it may break and cause bruise or injury.

B Door pocket

Lift up the door pocket while tapping the left/right of its bottom surface, and remove it. (It is fixed a little tightly.)

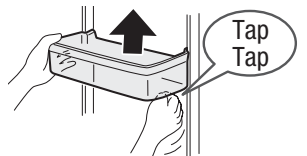

Insert the door pocket fully to the end when installing it.

Caution

If it drops, it may break and cause bruise or injury.

C Fixed shelf

Draw the shelf, and pull off the 2 pins on the lower right and remove it.

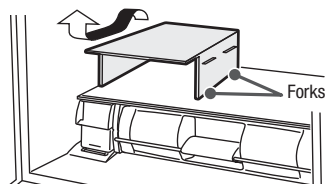

D Height adjustable lower shelf

Slightly lift up and pull out.

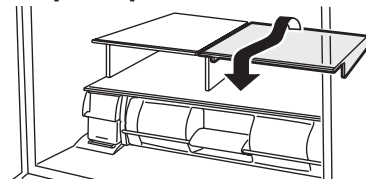

Caution

If you pull out the shelf straight, it may hit the door.

E Vacuum Case

How to remove

Pull out the Vacuum Case by slightly lifting up and moving up and down.

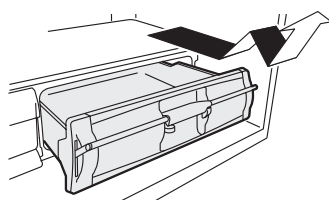

How to attach

Insert the Vacuum Case so that both right and left convex ribs on the case can slide under the guide rail of the Vacuum Container.

Lastly, hold down the handle to lock.

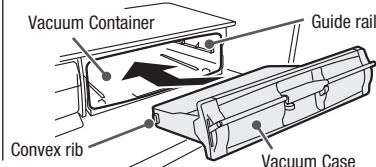

Request

Check that it is fixed properly by taking it in and out a few times.

F Ice Case (Ice Compartment) • Upper Freezer case (Upper Freezer)

Draw the door fully and lift up the case towards you.

Put the case bottom on the frame and set the case.

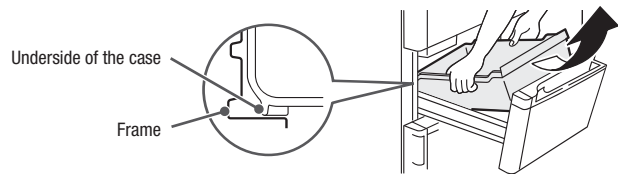

G Slide case and lower freezer case (Lower Freezer)

1 Draw the door fully, and draw the Slimline slide case and the Slide case respectively.

2 Lift up the Lower freezer case.

Caution

- Do not remove the Slimline slide case.

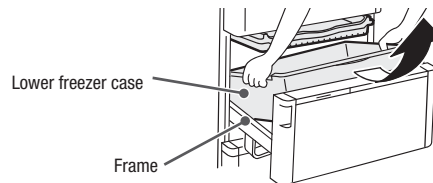
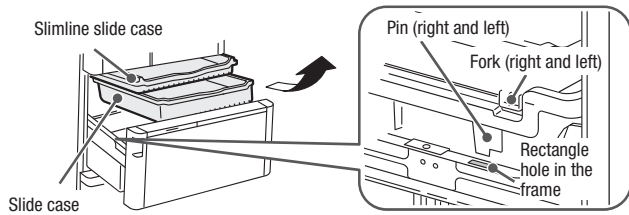

When installing it, insert the pins on the left/right of the Lower freezer case into the square holes on the frame to install it. Moreover, hitch the pins on the left/right of the Slide case to the outside of the Lower freezer case.

H Upper Case, Lower Case (Vegetable Compartment)

1 Draw the door fully and pull up the Upper Case as shown in the figure.

2 Lift up both sides of the door toward you and draw it slowly, and then place it on the floor.

3 Lift up the Lower Case toward you.

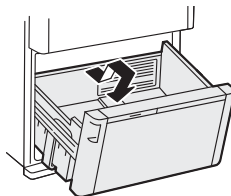
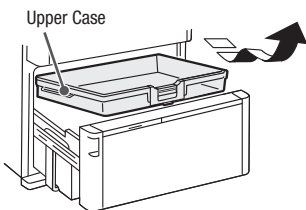

Caution

- Do not remove the door completely.

Caution

- Be careful. Water may drip from the backside of the lower case.

Caution

- The glass partition can't be removed.
- Do not remove the moisture unit and photocatalyst from the lower case.

How to attach the slide door (Ice Compartment/Upper Freezer/Lower Freezer/Vegetable Compartment)

Ice Compartment/Upper Freezer

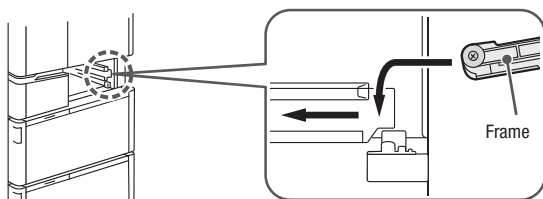

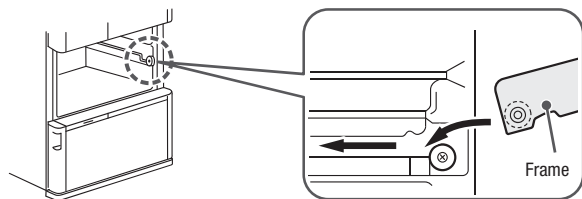

Lower Freezer/Vegetable Compartment



TROUBLESHOOTING

Check the following points before asking repair. Contact your dealer or our customer center if the problem still exists after checking them.

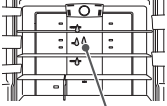

	When this happens	Check Item	How to solve/repair
Initial stage	Not cooled well.	It takes time to cool in summer or when a lot of foods are stored.	No trouble Immediately after installation, it may take more than 24 hours .
	No ice is made.	When using for the first time, it takes time to make ice because ice making starts after cooling fully. It may take more than 24 hours to make ice according to the amount of food and the way of packing it.	No trouble Open/close the door quickly and/or minimize the number of times of opening and closing the door. Allow clearance between each food in each compartment.
Open Button	The Open Button does not respond.	Isn't the setting of the Lock on the panel for operation is set to "ON" (locked)?	Cancel the lock of the Open Button. (→ Pg.61)
		Is Refrigerator Compartment Door open?	Operate after closing it.
		Isn't a water drop or dirt attached to the Open Button?	Wipe it with a soft cloth.
		Are you wearing gloves or applying a plaster?	Touch directly with your finger.
Automatic ice making is not properly performed	Ice cannot be made at all.	Did you touch adjacent Open Button wrongly?	Touch the target Open Button only.
		Is the auto ice maker set to "Off"?	Set it to "On" or "Quick" mode. (→Pg.56, 57)
		Is Water Supply indicator lamp turned on?	Pour water into the water supply container. (→Pg.56, 57)
		When water in the water supply container is getting low, Ice Maker may not make ice.	Add water until water level reaches to the "Container-full line" of the water supply container. (→ Pg.56)
		Is the water supply container pushed firmly until it is beyond the "container set position" line?	Push it beyond the "Container set position" line. (→ Pg.56)
		Do you push it to the end until it snaps?	Push the frame back until it snaps. (→ Pg.71)
		Is anything other than ice stored in the ice case?	Remove it from the Ice Case.
	It takes a long time to make ice. There is no ice in the ice tray.	Is the ice case filled with ice over the limit line of stored ice amount?	Level the ice. (→ Pg.57)
		Do you open the door frequently or store a large amount of food at a time? Refrigerator may not cool fully.	Minimize the number of times of opening and closing the door until it cools fully. Allow clearance as much as possible between each stored food.
		It may take more than 4 hours to make ice in winter.	No trouble
		Immediately after changing from "Off" to "On", it may take longer than usual to make ice.	No trouble
	Projection is generated on ice.	Does any food or package caught in the door of the Freezer or Ice Compartments prevent the door from closing completely?	Remove it if it is caught.
		Isn't the "Energy Saving" ("Save"/ "Trip") mode "ON"?	Exit the "Energy Saving" mode. (→ Pg.60)
	Stored ice becomes small. Ice sticks together.	It is frozen water collected in the ice tray groove.	It does not indicate any trouble.
Ice naturally becomes small or sticks together if ice is stored for a long term.		Dispose of old ice cubes, and try to make ice again.	
Do you open the door frequently or store a large amount of food at a time?		Open/close the door quickly or reduce frequency of opening and closing the door.	
Small ice is made.	Was the door or the drawer not temporarily shut completely?	Close the door completely.	
	Small ice may be made if only a small amount of water remains in the water supply container.	Add water until water level reaches to the "Container-full line" of the water supply container. (→ Pg.56)	
Connected ice is made.	If the frame is not set in place properly, ice cubes may stick each other.	Set the frame to the right place. (→ Pg.67)	
	If the ice tray is damaged, ice may not be easily separated from the ice tray and ice stuck together may be made.	Check that there is a flaw on the ice tray, and then consult with your dealer for replacement.	
There is white impurity in ice.	It is because the fine air bubble in water is contained in ice.	This is not malfunction.	
	Did you use mineral water to make ice?	Mineral contained in water may freeze and become white impurity in ice. It may remain after thawing in water, but it is harmless.	
Ice tray frame cannot be drawn.	Is "Off" indicator lamp turned on again?	The ice tray cannot be drawn when the auto ice maker is operating. Set it to "Off". When the "Off" indicator lamp is blinking, wait for 1 minute until "Off" is lit, and then draw the ice tray. (→ Pg.67)	
	Does any food or package caught in the door prevent the door from closing completely?	Remove it if it is caught.	
Refrigerator does not cool	Refrigerator does not cool. Frost and/or dew occur. Ice cream becomes soft.	Is food squeezed in? or Is a large amount of food put in at one time?	Follow the rules on the height of food that can be stored. (→Pg.54, 58) Allow clearance between each food in each compartment.
		Is the case fixed securely?	Install them correctly. (→ Pg.69)
		Food cannot be cooled enough, depending on the installation place or surrounding situation.	Check to see if the refrigerator is installed properly. (→ Pg.46)
		Isn't the "Energy Saving" ("Save"/ "Trip") mode "ON"?	Exit the "Energy Saving" mode. (→ Pg.60)
		Refrigerator may not cool fully when the temperature setting is "■".	Switch the temperature setting of the compartment where it does not fully cool to "■■■" or "■■■■". (→Pg.51, 55)
		Does the temperature around the refrigerator become high due to weather (ex: in summer)?	Switch the temperature setting of the compartment where it does not fully cool to "■■■■". (→Pg.51, 55, 59)
		Temperature in the refrigerator rises little by little while its door is open. If the door is opened/closed frequently or left open for a long time, temperature cannot easily lower.	Reduce the number of times of opening and closing the door, or open/close the door quickly.

	When this happens	Check Item	How to solve/repair	
Frost and/or dew occur	Frost and/or dew adhere to the refrigerator interior or the frame of the drawer compartment.	Was the door or the drawer not temporarily shut completely?	Check that any food or package caught in the door, and then close it completely.	
		The door may be opened/closed frequently or door may remain open for a long time.	Open or close the door quickly, or reduce frequency of opening and closing the door.	
		Frost or condensation may be formed when the warm air contacts with inside the compartment or the door frame.	Wipe it off with a dry cloth.	
		Frost or condensation is formed on the wall or any part of the freezer compartment due to the moisture in the air when the door is opened or closed.	No trouble Wipe it off with a dry cloth.	
	Dew adheres to the outside of the refrigerator (exterior, door gaskets, door and drawer compartment etc).	Dew may adhere to those parts when the indoor humidity is high (ex: rainy day).	No trouble Wipe it off with a dry cloth.	
		When the dew-proof heater is set to low, high humidity may cause condensation on the iron partition, the door gasket or the door.	Cancel the settings of the condensation prevention heater. Wipe it off with a dry cloth. (→ Pg.62)	
		When the temperature is set to "■■■■", it may cause condensation on the surface of the door.	Wipe it off with a dry cloth. Please set the temperature to "■■■".	
	Dew condensation occurs in the Refrigerator Compartment.	Condensation may form on the wall and/or around the cold air blowout port when the door is opened and closed frequently or the humidity is high around the refrigerator.	 Dew condensation	No trouble Wipe it off with a dry cloth.
	Dew condensation occurs in the Vegetable Compartment.	The humidity in the Vegetable Compartment, among others, space for aero-care zone is higher than in any other compartment. This is because it is necessary to ensure optimal freshness of vegetables, which is not a malfunction.		When it is undesirable that dew occurs, wrap food and then store.
		Water may drop into cases placed in the Vegetable Compartment due to dew concentration.		Water may cause damage to food, so wipe off water with a soft cloth.
If the moisture unit is blocked by food bag or container, dew may be formed in the space for aero-care zone.			Move the food bag or container blocking the moisture unit to other locations.	
Refrigerator cools overly	Refrigerator cools overly Food freeze.	"■■■■" is selected in the temperature setting.	Switch it to "■■■". (→ Pg.51, 55)	
		The surrounding temperature is lower than 5°C.	When the ambient temperature is low, the inside of the refrigerator may cool overly. Switch the temperature setting to "■■■".	
		Is it placed in front of the Cold Air Blowout Port?	Do not place any food in front of the cold air blowout port.	
Door is not in a horizontal state	Door is not in a horizontal state.	The installation site may not be level.	This does not affect the refrigerator performance. Adjust the refrigerator adjustable mount to keep it level if you want to correct it. (→ Pg.46)	
		Does the soft floor material sink in around the legs due to the weight of stored items?	Lay a firm board which has more than 1cm thickness on the floor if the refrigerator itself inclines.	
	More force is required to open the door immediately after closing the door.	It is because the air that entered the Refrigerator Compartment is rapidly cooled and the pressure in the Refrigerator Compartment temporarily lowers.	This is not malfunction.	
Another door opens after closing 1 door.	Another door may open for a moment by the wind pressure because cool air path connects each compartment.	This is not malfunction.		
Abnormal operating sound is generated	Annoying sound is generated by the refrigerator.	Does the floor bend?	Lay a firm board and then install the refrigerator thereon. (→ Pg.46)	
		Does the refrigerator come in contact with the wall or furniture, etc.?	Install the refrigerator with clearance around it.	
		Does the leg cover come off?	Install it firmly. (→ Pg.46)	
		You may feel that the operation sound is loud because the compressor operates in high-speed under the following conditions: the refrigerator does not cool fully on the occasion such as using it for the first time, opening/closing the door frequently, the surrounding temperature is high.	The sound becomes soft after cooling fully.	
		When it is set to "Freezer"/"Fridge"/"Quick", operation sound of the compressor or the fan motor gets louder because of high-speed revolution.	This is not malfunction.	
	Operation sound lasts long.	It is because the compressor operates in low-speed for conserving energy.	This is not malfunction.	
	Operation sound sometimes becomes louder.	It is because the system changes the operating power of the refrigerator according to the temperature change.	This is not malfunction.	
	When other sounds such as shown in the right table are generated by the refrigerator.	Sound like water flowing (trickling) Sound like collision (tapping) Sound like water boiling (bubbling up) Sound like meat roasting (sizzling)		These sounds are caused when the refrigerant flows or water flows/ evaporates to remove frost. This is not malfunction.
		Sound like squeaking (cracking) (knocking)		This sound is caused because the parts squeaks when the refrigerator temperature changes. This is not malfunction.
		Sound like something is caught (clacking) Sound like roaring (honking) Sound caused immediately after closing the door (booming)		These sounds are caused when the electric parts to control the refrigerator temperature operates. This is not malfunction.
Sounds caused by the Automatic ice maker (zooming) (rattling) (clunking)			These sounds are made when ice is separated from the ice tray of the auto ice maker or water is supplied to the ice tray. These sounds are also heard every 2 or 3 hours when the water supply container is empty. This is not malfunction. To stop the sound, touch the  button to change it to "Off". (→ Pg.57)	
Sound occurs sometimes (clacking)			This sound is caused when the refrigerator starts the operation to cool.	
Refrigerator becomes hot	The side of the refrigerator becomes hot. Hot air comes from the bottom of the refrigerator.	Hot air may come from the bottom of the refrigerator to exhaust the heat generated when the cooling device operates.	The temperature may rise to 50 – 60 °C immediately after installation or during summer. It does not pose safety or performance problems, but avoid touching it.	

TROUBLESHOOTING (CONTINUED)

	When this happens	Check Item	How to solve/repair
It smells strange	Plastic smells	This smell occurs because a lot of plastic parts are used in the refrigerator, but the smell decreases gradually while cooling.	This is not malfunction.
	Ice smells	Do the water supply container and/or water filter become dirty? Or does ice become old?	Wash them regularly to prevent "slime" and/or "fur". (→ Pg.67)
		Chlorine may strongly smell because chlorine in tap water is condensed.	This is not malfunction.
It smells in the refrigerator	Is any food which strongly smells stored without any wrapping?	The deodorizing function cannot completely remove all smells. Seal that kind of food with plastic film etc.	
There is something strange with the Vacuum Compartment	Hissing sound does not occur when opening.	Is the setting of the Vacuum Compartment to "Off (Non-vacuum)"?	Change the setting to "-1°C" or "+1°C". (→ Pg.53)
		Is the handle pulled up?	Hold down the handle to lock.
		Is the handle held down to the end and locked?	The vacuum function will not work unless it is locked. Lock it.
		Isn't the Vacuum Compartment Gasket removed?	Install the Vacuum Compartment Gasket.
		Is a food package or a hair caught in the vacuum compartment gasket and the support?	Remove any packing material of foods or other things which are caught in. Clean the vacuum compartment gasket if it is dirty. (→ Pg.65)
	It is not clear whether the Vacuum Compartment has been vacuumized.	Was the door of the Vacuum Compartment or the Refrigerator Compartment opened / closed just before?	Hissing sound may not occur because the vacuum pump enters the preparation state for starting the operation, but it does not indicate any trouble.
		The Vacuum Compartment has been vacuumized properly if a vacuum releasing sound (hissing sound) is heard when opening it.	-
	The handle cannot be locked.	Is there any food etc. caught in the inner part of the Vacuum Compartment Case or the vacuum compartment gasket?	Remove any food if it is caught in.
		Is the Vacuum Case set in place?	Attach the Vacuum Case according to the procedure. (→ Pg.68)
	Booming sound and vibration occur around the Vacuum Compartment.	This sound is caused when the vacuum pump operates.	This is not malfunction.
You can stop the vacuum pump operation when you want to stop the sound (ex: night time).		Change the setting of the Vacuum Compartment to "Off". (→ Pg.53) (It is set to Off (Non-vacuum))	
If any sound or vibration occurs frequently, some object may be caught in the Vacuum Case or the Vacuum Compartment Gasket may be dirty.		Remove any packing material of foods or other things which are caught in. Clean the vacuum compartment gasket if it is dirty. (→ Pg.65)	
Dew or frost is formed inside the Vacuum Compartment and around the Vacuum Case.	The moisture from the juicy food may cause dew condensation and/ or frost adhering insider the compartment because the Vacuum Compartment is sealed.	It is recommended to wrap the juicy food with plastic film, etc. Wipe dew and /or frost off with a soft cloth wet by lukewarm water.	
The surface of stored vegetables is dented or gets discolored.	Is any vegetable sensitive to low temperature such as eggplant and cucumber stored?	Move them to the Vegetable Compartment. (→ Pg.53)	
Food in the Vacuum Compartment freezes.	Is the Vacuum Compartment set to "-1°C" or "OFF (Non-vacuum)"?	Set the "+1°C". (→ Pg.53)	
[E] display on the Open Button flashes	[E] flashing	This flashing shows that there is a problem.	Consult your dealer.
	On flashing	Some foods, etc. may come into contact with the ice tray.	Empty the Ice Compartment and do the "Ice Maker Cleaning". (→ Pg.66)
	-1°C flashing	It may be in the operation check mode for serviceman. (※1)	It will return to the normal mode after about 15 minutes. There is no problem with using the refrigerator.
	Auto Door Auto Drawer flashing	It may be in the operation check mode for serviceman. (※1)	It will return to the normal mode after about 10 minutes. There is no problem with using the refrigerator.
	Quick On Off All indicator lamps flash	It is in process of Ice Maker Cleaning.	Read "HOW TO MAINTAIN THE AUTOMATIC ICE MAKER". (→ Pg.66)
	Off flashing	It will flash if you "Off" during the ice making process.	Check how to clean the "Ice Tray". (→ Pg.67)
	All displays flashing	Door remains open for more than 1 minute. (ex: door is not completely closed.)	Check "Door Alarm". (→ Pg.61)
	Blinks other than those above	It may be in the operation check mode for serviceman. (※1)	Consult your dealer.

※1 Touching the button long (more than 10 seconds), the refrigerator may go into the operation check mode.

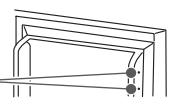

	When this happens	Check Item	How to solve/repair
Auto Door	Noise is loud. There is an abnormal noise.	Hitting sound (thumping sound)	This is the operating sound of the Auto Door. This is not malfunction.
		Buzzing sound (whir) (whir)	This is the operating sound of the Electric Refrigerator Unit. This is not malfunction.
		The operation sound of the Auto Door differs depending on doors (left or right).	This may vary depending on installation conditions of the refrigerator or the volume of foods stored in the door pocket. This is not malfunction.
	Auto Door won't open even if touching the Control Pane.	Is the Auto Door light not lit? Turn on the light.	Turn on the Auto Door indicator lamp. (→ Pg.48)
		Isn't the Ice Compartment or the Upper Freezer opened?	Close the slide door and then touch the Open Button of the Auto Door.
	The Auto Door does not close.	Is any food or food bag caught on the compartment?	Remove foods and others that are caught in.
		Did a power failure occur or did the compartment knock against any obstacle during electrical operation?	Auto Door stops on the way, so push in the door with hand.
Auto Door does not open widely.	Don't stored beverages or foods make contact with the wall in the Refrigerator Compartment?	Remove beverages or foods that make contact with the wall.	
	Installation site may not be leveled out.	Opening angle of the Auto Door may vary or the door may go back a little after it is opened automatically depending on installation conditions of the refrigerator, but this is not malfunction.	
Auto Door moves even if it is locked on the Open Button.	Auto Door can not be locked from the Open Button.	In order to stop Auto Door, unlock the Open Button first, and then touch  button for 3 seconds or more until it beeps twice. (→Pg.48, 61)	
Auto Drawer	Noise is loud. There is an abnormal noise.	Hitting sound (thumping sound)	This is the operating sound of the electrical drawer compartment. This is not malfunction.
		Buzzing sound (whirring, grunt)	This is the operating sound of the electrical drawer compartment. This is not malfunction.
		Operation sound of the Vegetable Compartment is louder than that of the Lower Freezer.	Operation sound of the "vegetable compartment" is louder than the "lower freezer". This is not malfunction.
	The compartment does not open even if the electrical drawer switch is pressed.	Is the Auto Drawer light not lit? Turn on the light.	Turn on the Auto Drawer indicator lamp. (→ Pg.49)
		Is either one of the lower freezer or the vegetable compartment open?	Close the open electrical drawer compartment and then press drawer switch for the compartment you want to open.
	The Auto Drawer does not open/close.	Is any food, food bag or plastic wrap, etc. caught on the compartment?	Remove foods and others that are caught in.
		Did a power failure occur or did the compartment knock against any obstacle during electrical operation?	The door does not open/close smoothly because the electrical drawer function is stopped before the operation completes. Manually push in the door with strength. Otherwise, unplug the power plug with the door drawn, and connect it after 10 seconds.
The Auto Drawer does not open much.	The Auto Drawer is pulled out by approx. 15 cm or more.	The length may vary depending on installation conditions of the refrigerator, or the Auto Drawer may go back a little after the door is opened automatically. This is not malfunction.	
Auto Drawer moves even if it is locked on the panel for operation.	Auto Drawer can not be locked from the panel for operation.	In order to stop Auto Drawer function, unlock it first on the panel for operation, and then touch  button for 3 seconds or more until it bleeps. (→Pg.49, 61)	
Others	You feel electricity a little when touching the main body of the refrigerator.	_____	The refrigerator may be charged with static electricity, but there is no problem with the safety.
	Radio and/or television are disturbed by noises.	It is caused by the electromagnetic radiation slightly generated from this refrigerator.	Install the refrigerator away from the television, radio and interphone. It is recommended to connect the power plug to the power outlet separated from the antenna terminal and ground the refrigerator. (→ Pg.47)
	There are thin lines like scratches on the plastic parts.	Those lines are caused by the liquid resin flowing when plastic is molded.	They are especially conspicuous for the transparent parts, but there is no problem with the strength.
	There are waving and/or distortions on the door surface, the side and the top surface of the refrigerator.	Slight waving and/or distortions are generated in the manufacturing process of the refrigerator.	They may be conspicuous according to the position of the light source and/or the brightness etc., which is not malfunction. There is no problem with the performance.
	The Open Button is unlit.	Approximately 40 seconds after the end of operation, indicator lamps will be turned off.	This is not malfunction. However, the setting of "Save" mode, indicator lamps of "Fridge", "Freezer" and "Quick", and indicator lamps of "Off" and "Water" and "eco operation" at work are still lit. Open the door of the Refrigerator Compartment or touch  button to turn it on.
		There is a small hole inside the door.	This hole is used to escape the air inside when filling the heat insulation material into the door during the production process.  Hole (inside of the door)
	The electric supply failed.	Reduce the number of times of opening and closing the door and avoid storing food additionally until the electric supply is restored.	Please check each setting on the panel for operation after the power comes back on.
	The refrigerator is not expected to use for a long term.	Remove all the items in the refrigerator.	Leave all the doors open to dry the refrigerator for 2 or 3 days. (→Pg.64-67)
	When no ice-making is required.	Please turn on "Off".	See "Stop Ice Making". (→ Pg.57)
	Remove frost.	Any operation to remove frost is not required because this refrigerator remove frost automatically.	Thawed water is collected in the evaporating tray and automatically evaporates.
	Transporting and moving care.		See "Transporting your refrigerator (transport for moving)" (→ Pg.47)

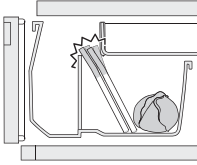
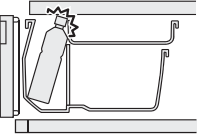
TROUBLESHOOTING (CONTINUED)

	When this happens	Check Item	How to solve/repair
Others	The Vegetable Compartment door doesn't close / When the Vegetable Compartment door is opened, the upper case doesn't go back to the locking position.	Is any food, etc. caught between the upper case and the lower case? 	Remove it if any.
		Does PET bottle, food, etc. come in contact with the locking handle of the upper case? 	Store PET bottle, food, etc. so that they don't come in contact with the locking handle.
	Glass is broken (door glass, glass shelf, glass partition)	_____	Do not touch a broken glass, but contact your dealer for repair soon.
	When a midge fly, etc. enters in the refrigerator	Are there fruit flies around it?	Keep the environment clean. Put something a fruit fly hates or fruit fly traps or something like that.
Is there any food with strong flavor in the refrigerator?		Cover food with the lid so that fruit flies can't be attracted by the flavor.	
Is the door left open for a long time?		Please close the door as soon as possible.	

AVAILABLE PARTS

■ If you order any part listed below, specify the model of your refrigerator to a dealer for purchasing genuine parts.

Subject	Product Name	Product Model	
Ice smells ● Water filter may be old and dirty (available about 3 or 4 years, as a guide)	Water filter for the automatic ice maker	RJK-30	
Vacuum state can't be maintained ● It may be damaged, deformed or discolored.	Vacuum compartment gasket	R-C6700 321	

有關碳氫化合物的冰箱 / 可容納的食品重量

ABOUT NON-CFC REFRIGERATORS/STORABLE WEIGHT

有關碳氫化合物的冰箱 About non-CFC refrigerators

- 本冰箱所使用冷媒及其他斷熱材料皆無使用氟氯化碳 而是使用碳氫化合物。碳氫化合物不會破壞地球臭氧層、對地球溫室效應的影響非常小、屬於環保物質。
- 碳氫化合物為可燃型物質。冷媒密封於冷媒迴路管中、在一般的使用情況下應該不會發生外洩。但萬一有冷媒管線損壞的情況發生、請遠離火源及避免使用電器用品、將門窗打開以利空氣流通。之後、請立即與經銷商或日立技術中心聯絡。
- Instead of CFCs, hydrocarbons are used in the coolants and insulation materials used in this refrigerator. Hydrocarbons do not damage the ozone layer, and they are environmental-friendly materials, having an exceptionally small affect on global warming.
- Hydrocarbons are flammable. The coolants are sealed in the coolant circuitry, and with normal operation they will not leak, but should the circuitry be damaged, refrain from using flames or other electrical products, and open windows for ventilation. After that, please contact the dealer or Hitachi customer service centre.

可容納的食品重量 Storable weight

可容納於層架或收納盒內的食物重量如下：

The following table shows the weight of food that can be stored on the shelves and in the cases.

	零件名稱 Name of parts		R-E6800XS, R-E6800S R-E6800XH, R-E6800H R-E6800XV, R-E6800V R-E6800XND, R-E6800ND R-E6800XN, R-E6800N
冷藏室 Refrigerator compartment	可調式層架上段 可調式層架中段 可調式層架下段, 固定層架 真空冰溫室上方的層架 真空冰溫室盒 活動式萬用盒	Height adjustable upper shelf Height adjustable middle shelf Height adjustable lower shelf, Fixed shelf Upper shelf of the vacuum compartment Vacuum compartment case Multiuse Egg Case	21.0kg 21.0kg 21.0kg 11.0kg 5.0kg 2.0kg
製冰室 Ice compartment	儲冰盒	Ice case	請勿存放不是本自動製冰機製成的冰塊。 (→ 21頁) Do not store any ice cubes other than the ones made by the automatic ice maker. (→ Pg.57)
上層冷凍室 Upper freezer	上層冷凍盒	Upper Freezer case	9.0kg
下層冷凍室 Lower freezer	上層滑動盒 中層滑動盒 下層冷凍盒	Slimline slide case Slide case Lower freezer case	5.5kg 7.0kg 17.0kg
蔬果保鮮室 Vegetable compartment	上層滑動盒 下層置物盒	Upper Case Lower Case	8.5kg 22.0kg

關於廢棄之重要警告 Severe warning signs for Disposal

隔熱材料中含有環戊烷 (Cyclopentane)。

當要處理隔熱材料中之氣體時，必須依照特殊的廢棄處理程序。

要廢棄本產品時，為了不會對環境造成不良影響，請詢問當地的相關機關。

Cyclopentane is used in the insulation material.

The gases in insulation material require a special disposal procedure.

Please contact your local authorities in regard to the environmentally safe disposal of this product.

AFTER-SALES SERVICE

關於售後服務

Please contact the following Hitachi Service Centre if power cord is damaged or service is required.

If some malfunction occurs during operation, unplug the power plug immediately and contact the service centre to have the refrigerator repaired.

電源線受損或需要維修時，請直接洽詢下列日立服務中心。

使用中出現異常現象時，請立即拔掉電源插頭以及聯絡售後服務中心以進行修理。

- Hong Kong
Hitachi (Hong Kong) Ltd.
18/F., Ever Gain Centre, 28 On Muk Street, Shatin,
N.T., Hong Kong, China
Tel : +852-2753-5386
Fax : +852-2753-0993
- Singapore
Hitachi Home Electronics Asia (S) Pte. Ltd.
438A Alexandra Road, #01-01/02/03,
Alexandra Technopark, Singapore 119967
Tel : +65-6536-2520
Fax : +65-6536-2521
- 香港
香港日立有限公司
中國 香港 新界 沙田 安睦街 28 號 永得利中心 18 樓
Tel : +852-2753-5386
Fax : +852-2753-0993
- Indonesia
PT. Hitachi Modern Sales Indonesia.
12/F Wisma SLIPI Suite 1202
Jl. Let. Jend. S. Parman Kav.12
Jakarta 11480, Indonesia
Tel : +62-21-530.7211
Fax : +62-21-548.1883
- India
Hitachi Home & Life Solutions (India) Ltd.
9th Floor, Abhijeet, Mithakhali Six Roads
Navrangpura, Ahmedabad - 380006
Tel : +91-079-3532-4848/+91-079-30414747
E-mail: customercare@hitachi-hli.com

About Non-fluorocarbon refrigerator

- This refrigerator, including refrigerant and the heat insulator, is using hydrocarbon (non-fluorocarbon). The hydrocarbon is a material that does not rip up the ozone and have very little influence on global warming. It is the global environment concern material).
- R600a refrigerant is flammable. But the refrigerant is being sealed up by the refrigerate circuit, and never leak by usual use. In case of the refrigerate circuit being damaged by any chance, please avoid the use of fire and electric product, open the window and ventilate. Afterwards, please contact Hitachi Service Center.

Severe warning signs for Disposal

Cyclopentane is used as in the insulation. The gases in insulation material require a special disposal procedure. Please contact your local authorities in regard to the environmentally safe disposal of this product.



This symbol mark means that used electrical and electronic products shall not be mixed with general household waste. Do not try to dismantle the system and unit by yourself as this could have harmful effects on your health and the environment. Refrigerators must be treated at a specialized treatment facility for recycling and recovery and shall not be disposed of in the municipal waste stream. Please contact the installer, dealer or local authority for more information.

Hitachi Tokyo Japan

R-E6800XS R-E6800S [Ⓐ]
R-E6800XH R-E6800H
R-E6800XV R-E6800V
R-E6800XND R-E6800ND
R-E6800XN R-E6800N